

Outsunny

INbcb011V02_GL

845-030

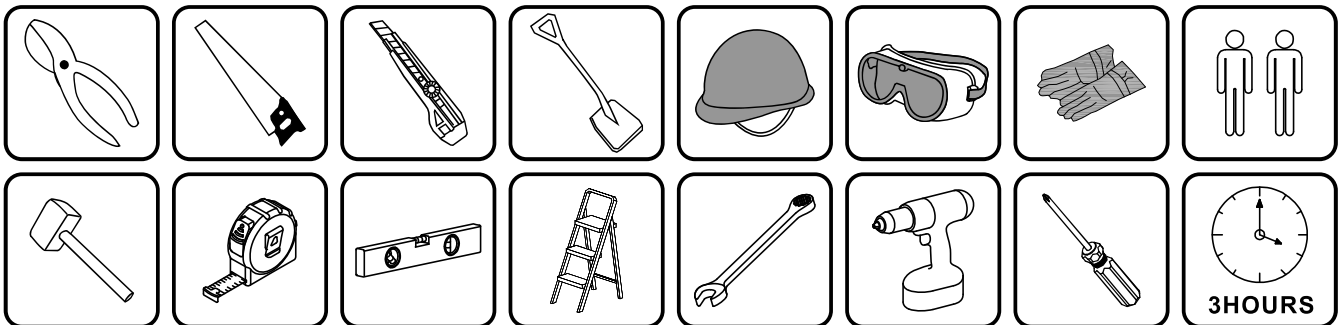
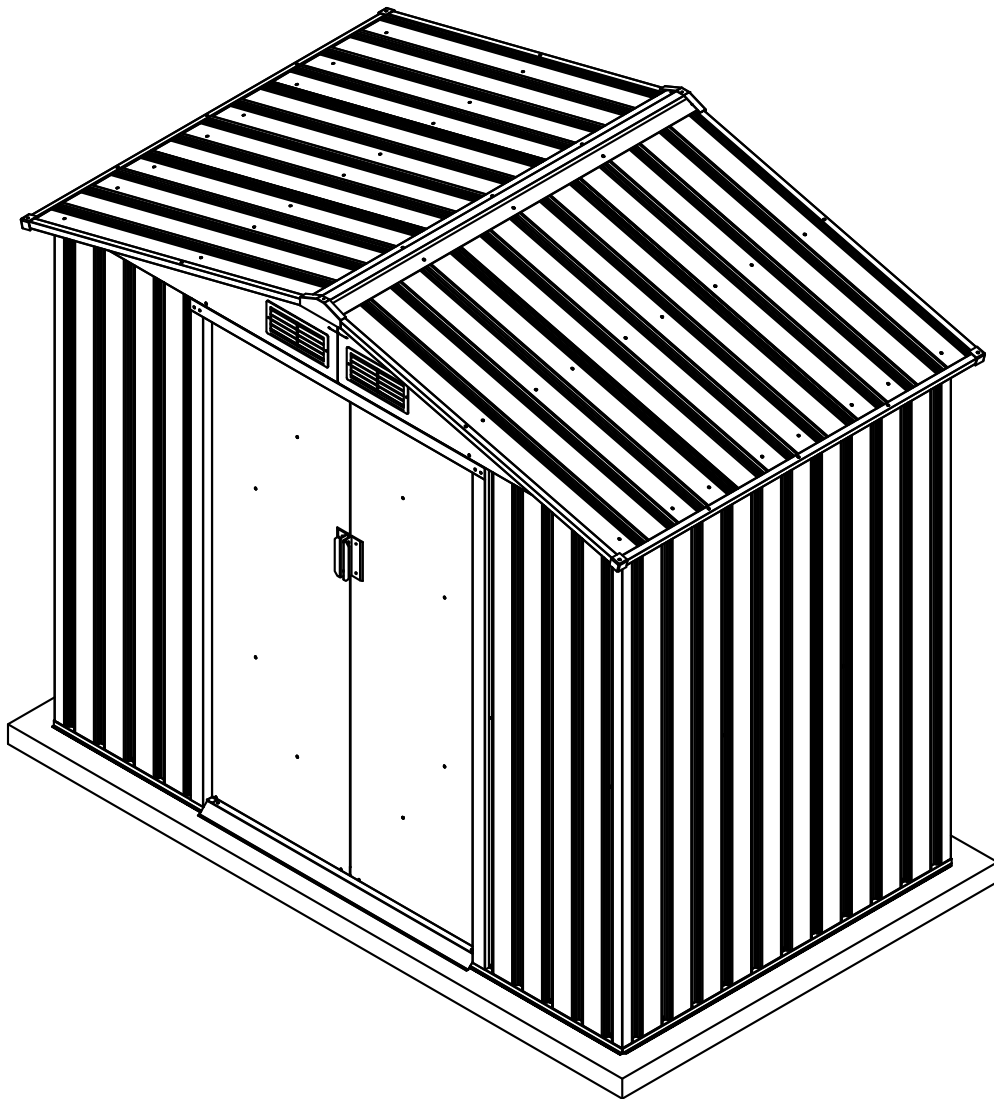

Συνιστώμενα εργαλεία

ΕΓΧΕΙΡΙΔΙΟ ΣΥΝΑΡΜΟΛΟΓΗΣΗΣ & ΟΔΗΓΙΩΝ

Ελέγξτε τους τοπικούς οικοδομικούς κώδικες σχετικά με τις βάσεις, τη θέση και άλλες απαιτήσεις πριν ξεκινήσετε την κατασκευή. Μελετήστε και κατανοήστε αυτό το εγχειρίδιο κατόχου με σημαντικές πληροφορίες και χρήσιμες συμβουλές για ευκολότερη και πιο ευχάριστη συναρμολόγηση.

Οδηγίες συναρμολόγησης:

Εξετάζοντας όλες τις οδηγίες και τις κατάλληλες πληροφορίες πριν ξεκινήσετε, βεβαιωθείτε ότι ακολουθείτε προσεκτικά τη σειρά βημάτων για επιτυχημένα αποτελέσματα.

Βάση δαπέδου:

Μια καλή τοποθεσία για το αποθηκευτικό κτίριο είναι ένας τετράγωνος και επίπεδος χώρος με καλή αποστράγγιση.

Ένα ισχυρό πλαστικό φύλλο (πάχος: τουλάχιστον 1 SOmm) πρέπει να τοποθετηθεί κάτω από τη βάση για να βοηθήσει στη μείωση της ανερχόμενης υγρασίας από το έδαφος, μειώνοντας έτσι τη συσσώρευση συμπύκνωσης στο υπόστεγο. Το κτήριο αποθήκευσης σας πρέπει να είναι αγκυρωμένο για να αποφευχθεί η ζημιά από τον άνεμο. Αφού ασφαλιστεί, συνιστάται ιδιαίτερα η εφαρμογή σιλικόνης κατά μήκος του εσωτερικού της ράγας βάσης για την ελαχιστοποίηση της συμπύκνωσης.

Λίστα ανταλλακτικών και ανταλλακτικών:

Πριν ξεκινήσετε, διαχωρίστε και αναγνωρίστε όλα τα εξαρτήματα και το υλικό για να βεβαιωθείτε ότι διαθέτετε όλα τα απαραίτητα εξαρτήματα για το κτίριό σας (ανατρέξτε στη σελίδα Λίστα ανταλλακτικών).

Εάν διαπιστώσετε ότι λείπει κάποιο εξάρτημα, ενημερώστε τον πωλητή εντός μίας εβδομάδας από την παραλαβή του προϊόντος. Μην επιχειρήσετε να συναρμολογήσετε το κτίριο εάν λείπουν εξαρτήματα, διότι οποιοδήποτε κτίριο που έχει μείνει μερικώς συναρμολογημένο μπορεί να υποστεί σοβαρή ζημιά από ελαφρούς ανέμους.

{ Παρακαλούμε αποκόψτε το προστατευτικό στρώμα ασφαλείας πριν από τη συναρμολόγηση, κρατήστε την ετικέτα με τον αριθμό ανταλλακτικού εάν χρειάζεται)

Η ασφάλεια πρέπει να τεθεί στη θέση No. 1:

1 Επιλέξτε μια στεγνή και ήρεμη μέρα για τη συναρμολόγηση σας. Απαιτούνται ομαδικές εργασίες (δύο ή περισσότερα άτομα) κατά τη συναρμολόγηση.

2 Φορώντας γάντια ασφαλείας, προστασία ματιών και μακριά μανίκια κατά τη συναρμολόγηση για την αποφυγή τραυματισμού. Δώστε προσοχή στην αιχμηρή άκρη ορισμένων εξαρτημάτων.

3 Δεν επιτρέπεται η είσοδος παιδιών και κατοικίδιων στο εργοτάξιο.

4 Μην συγκεντρώνετε ποτέ το συνολικό σας βάρος στην οροφή του κτιρίου. Όταν χρησιμοποιείτε μια σκάλα, βεβαιωθείτε ότι είναι ασφαλής.

Φροντίδα & Συντήρηση:

1 Διατηρήστε το υπόστεγο καθαρό με μαλακό πανί, χρησιμοποιήστε νερό εάν χρειάζεται.









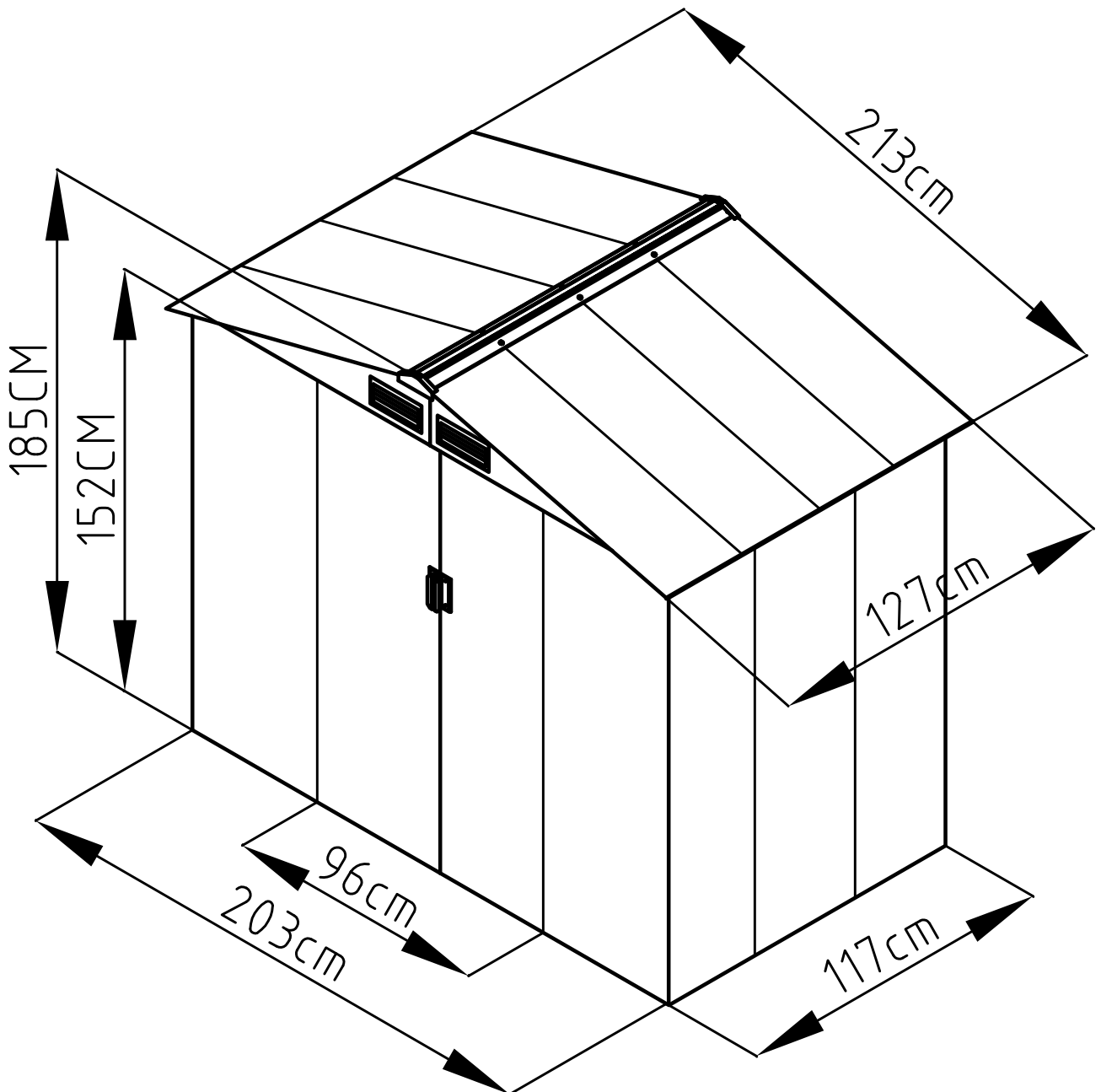
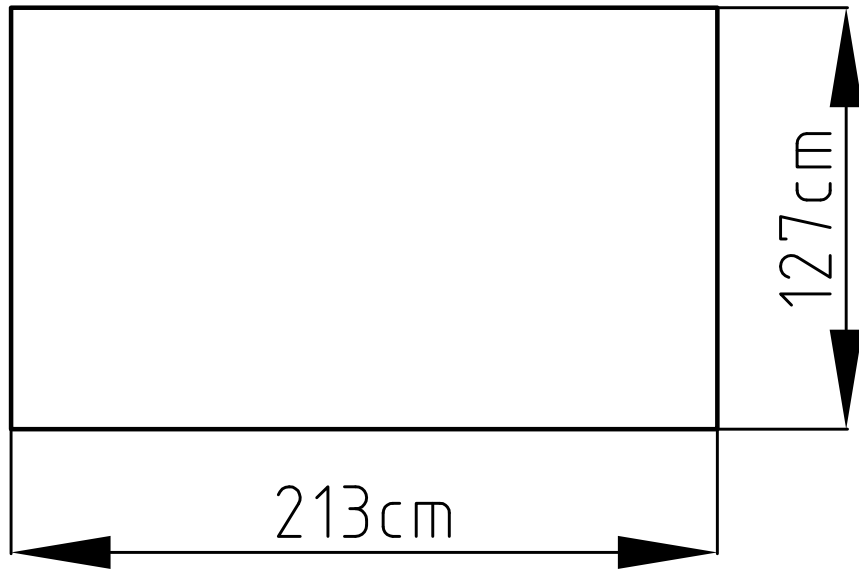





2 Κρατήστε τις ράγες της πόρτας μακριά από βρωμιά και άλλα πράγματα που τις εμποδίζουν να γλιστρήσουν εύκολα.





















3 Καθαρίστε το χιόνι με τα απαραίτητα εργαλεία για να βεβαιωθείτε ότι είναι ασφαλές να μπει μέσα. Το δυνατό χιόνι μπορεί να προκαλέσει κατάρρευση, βεβαιωθείτε για την ασφάλεια πριν μπει μέσα.

4 Το υπόστεγο δεν είναι φτιαγμένο για να ζει αλλά να αποθηκεύει πράγματα.

5 Παρακαλούμε προσθέστε λίγο λάδι στο επάνω και κάτω συρόμενο κανάλι της πόρτας για να κάνετε ομαλή ολίσθηση της πόρτας.



Name of parts	Section	QTY(pcs)
Box 1/2		
Bm-A7		8
Bm-A7a		1
Am-A23		2
Am-A24		4
Am-A25		2
Am-A28		1
Instruction manual		1
Box 2/2		
Bm-8		4
Bm-A30		1
Bm-A35		1
As-A19		2
As-A20		2
Bs-A1		1
Bs-A2		1
Bs-A3		2
Bs-A4		1
Bs-A5		1
Bs-A6		1
Bm-16		1
Bm-17		1
Bs-A18		1
Am-26		2
As-A38		2
As-A39		2
Bs-A9		1
Bs-A10		1

Name of parts	Section	QTY(pcs)
As-A13		2
Bs-A11		1
Bs-A12		1
As-A22		4
T-A29		2
T-A29a		2
Bm-31		2
Bm-A32		4
Bs-A33		1
Bs-A34		1
Bs-A36		1
Bs-A37		1
T-P7		1
T-P1		4
T-P2		4
T-P3		4
T-P4		2
TP5A		4
T-P6		2
T-P8		2
Am-A40		150
Am-A41		210
Am-A42		16
Am-A43		62
Am-A44		84
V-A1		5
V-A2		2

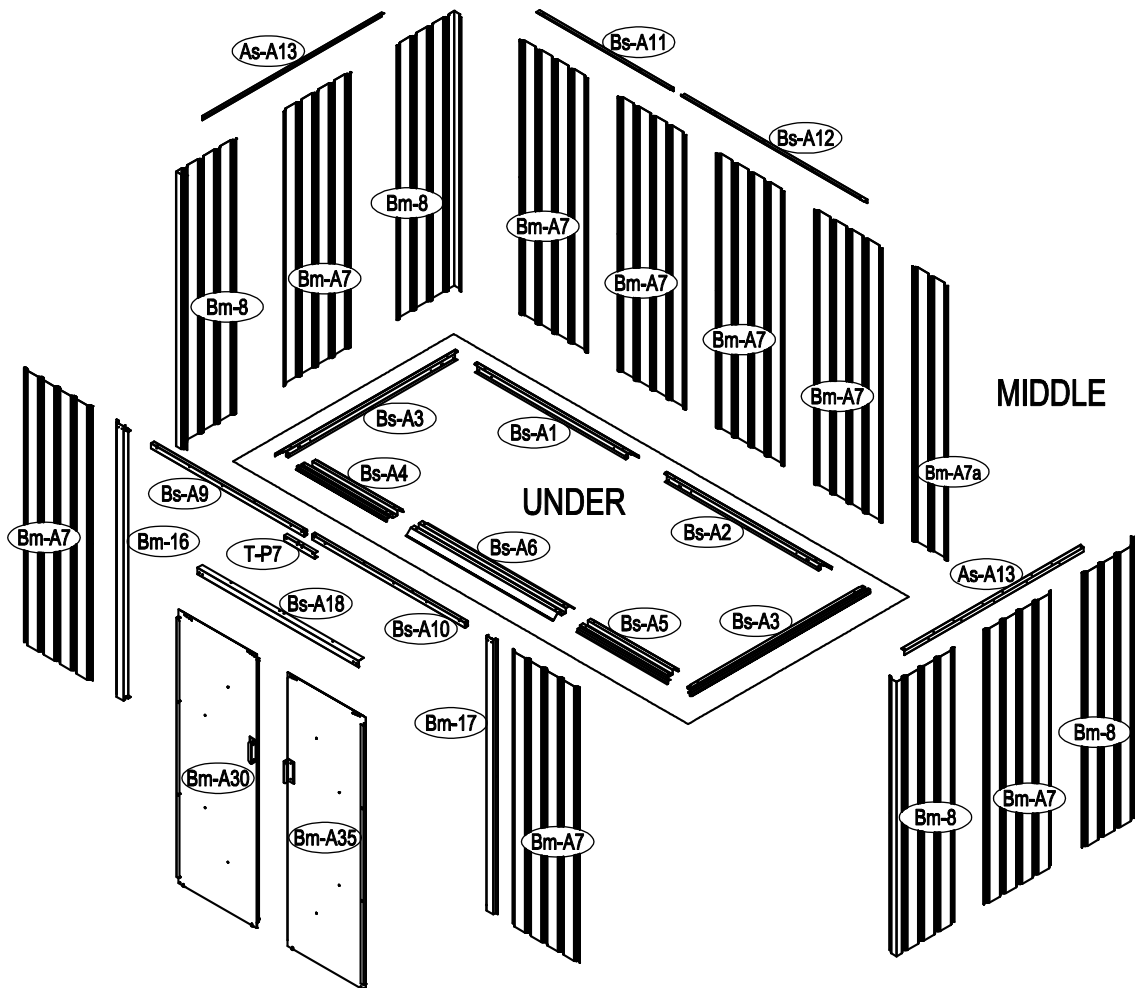
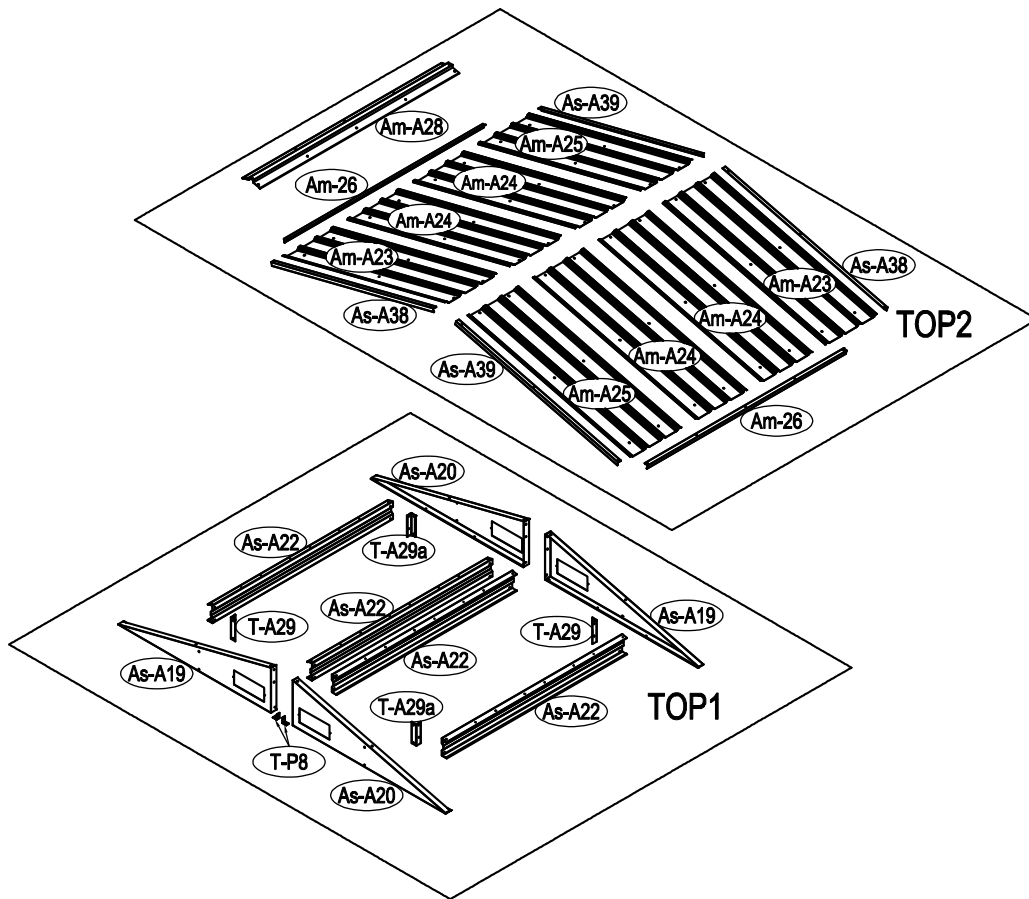

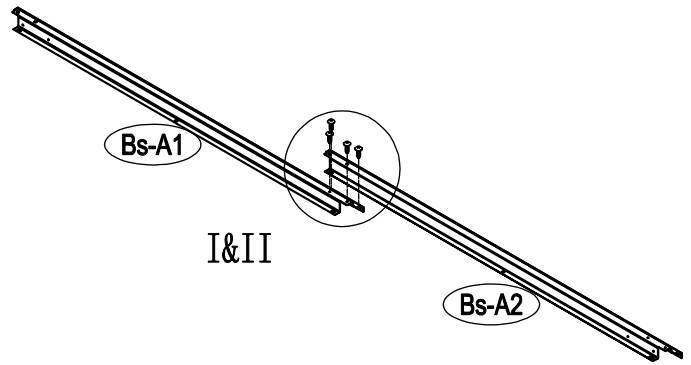
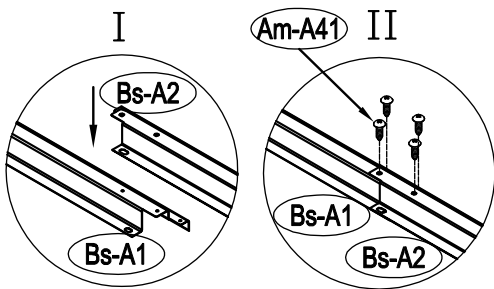

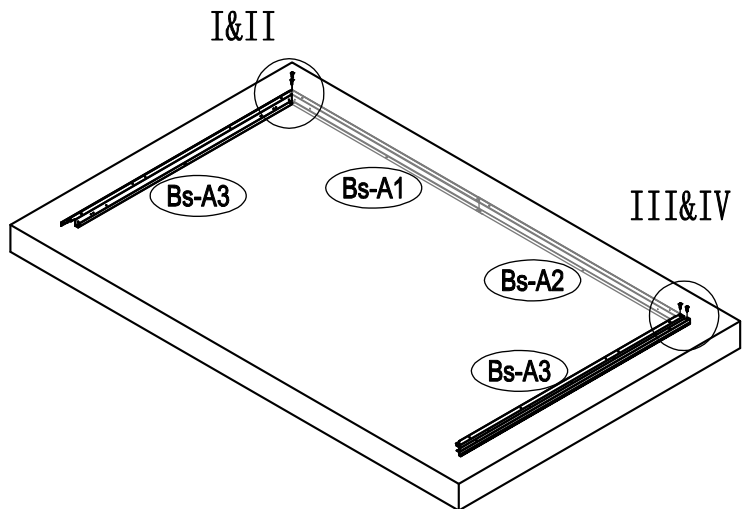
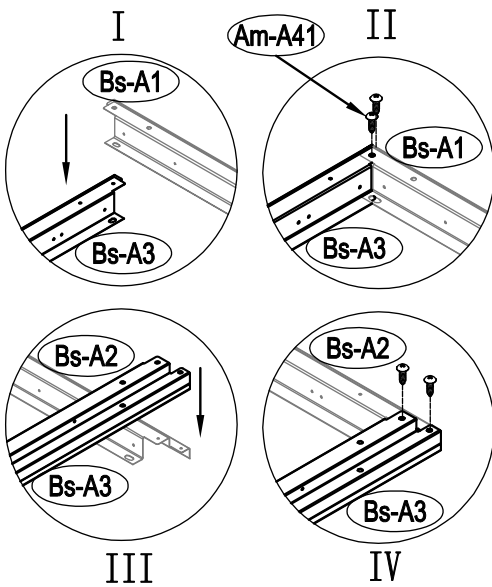

Am-A41		x4
--------	---	----



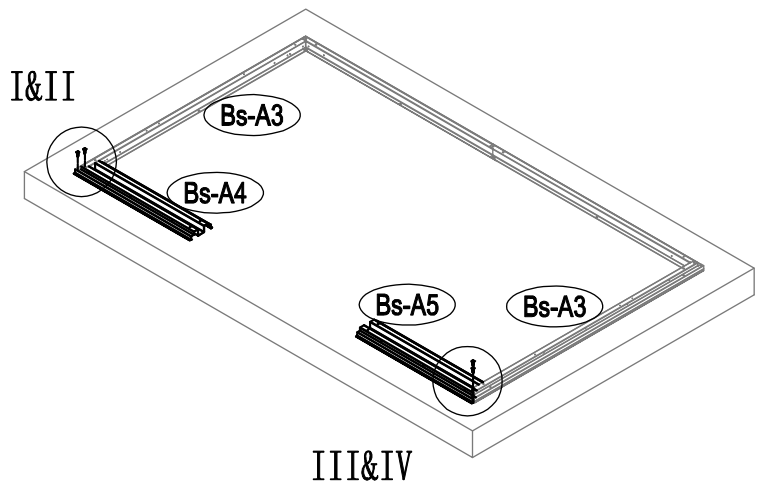
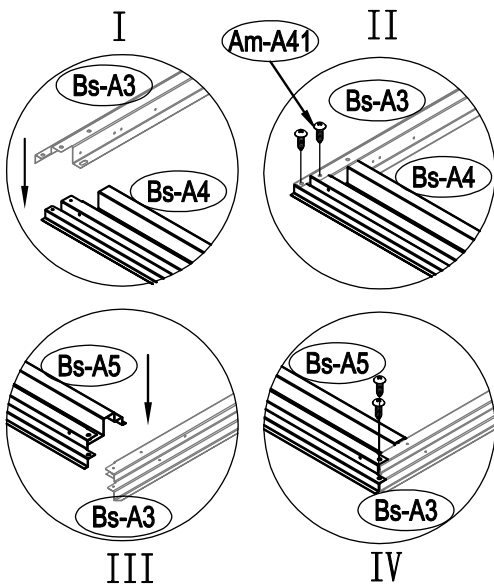

Am-A41		x4
--------	---	----



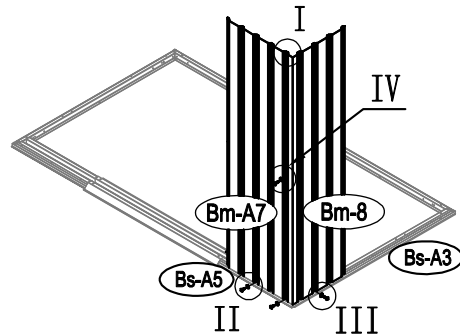
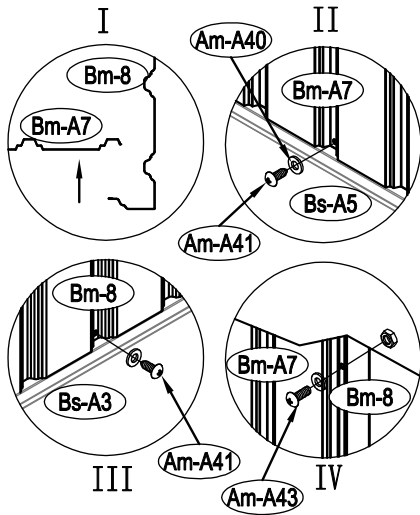
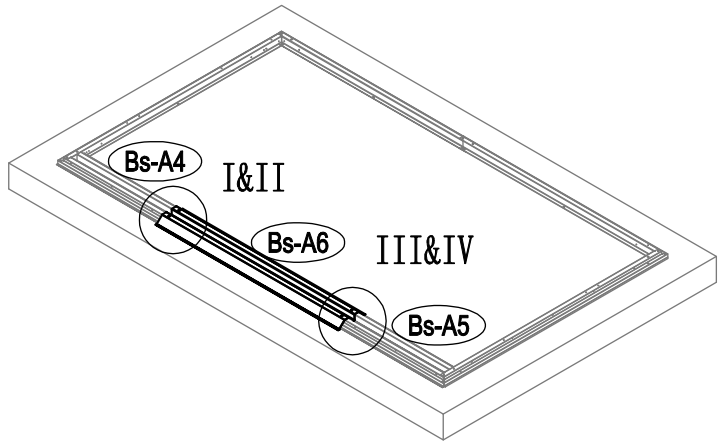
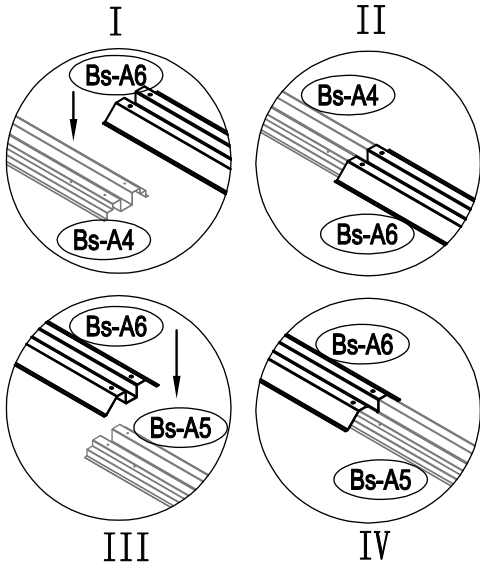

Am-A41		x4
--------	---	----

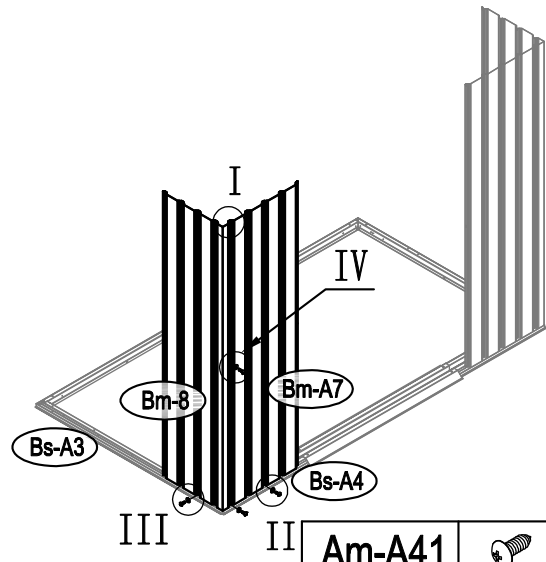
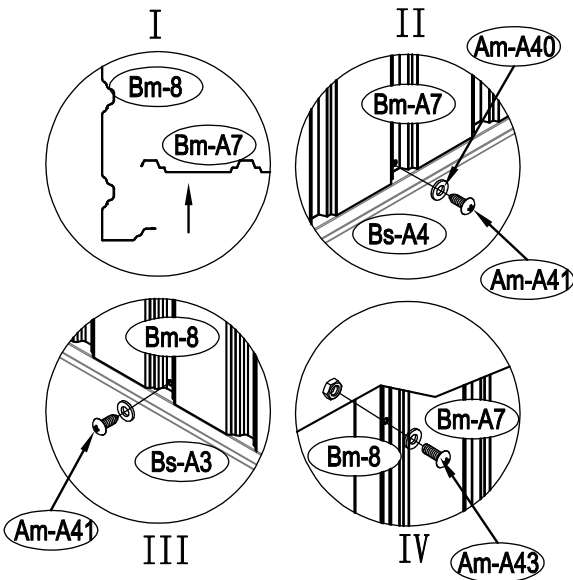

Am-A41		x3
Am-A43		x1



Am-A41		x3
Am-A43		x1

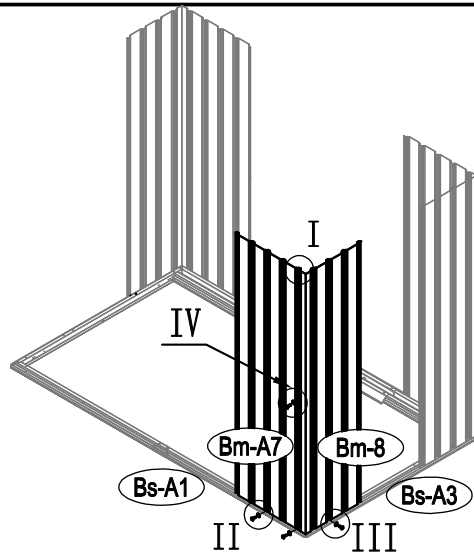
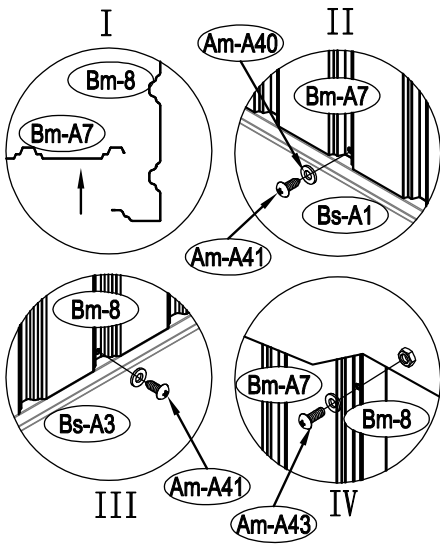

Am-A41		x3
Am-A43		x1

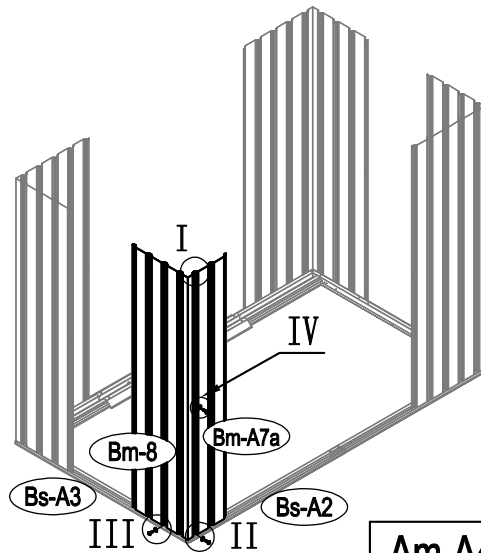
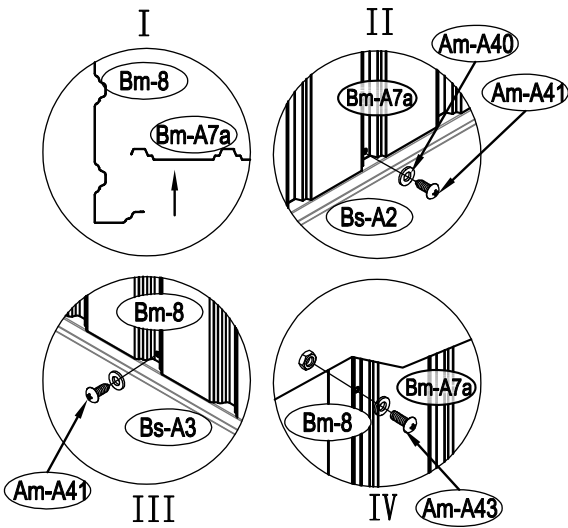

Am-A41		x2
Am-A43		x1

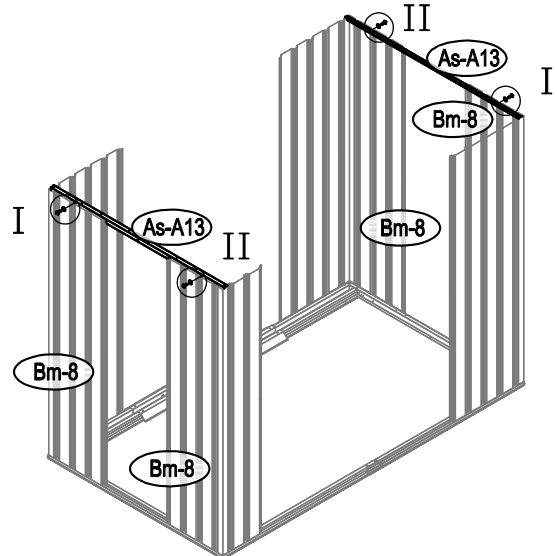
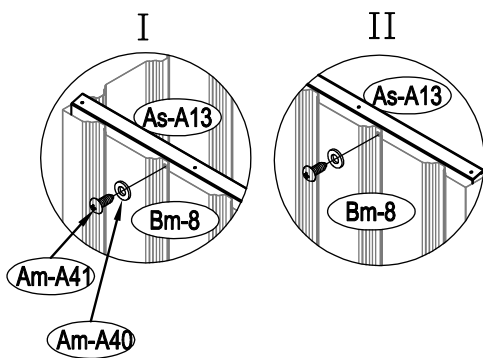

Am-A41		x4
--------	--	----

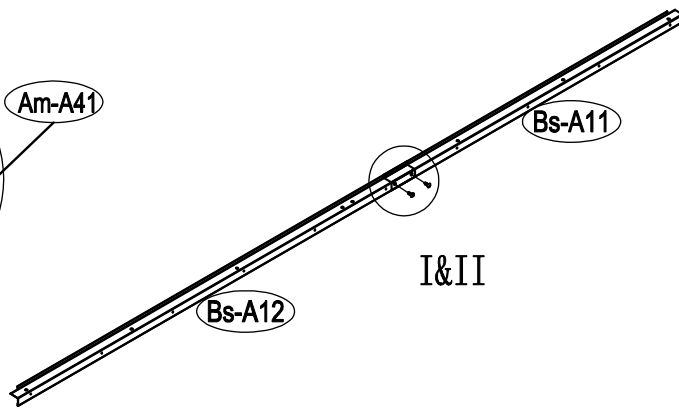
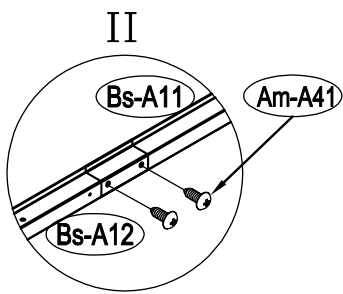
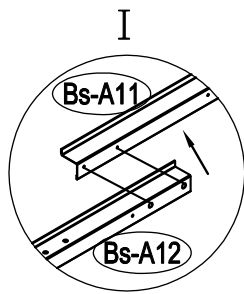

Am-A41  x2

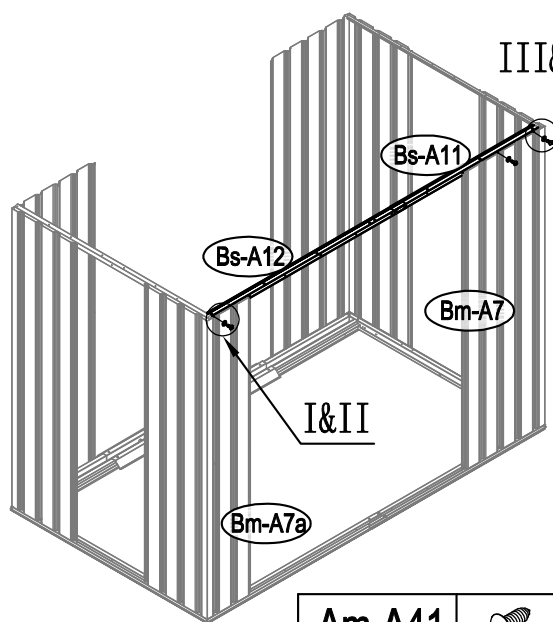
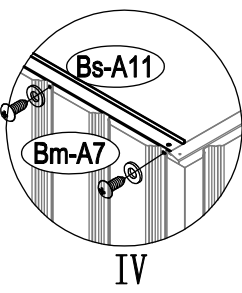
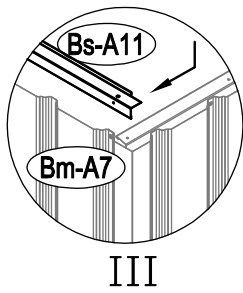
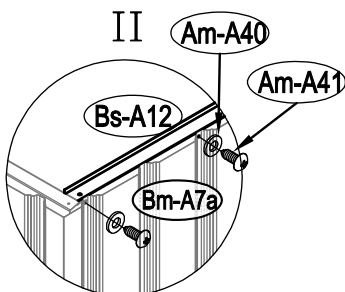
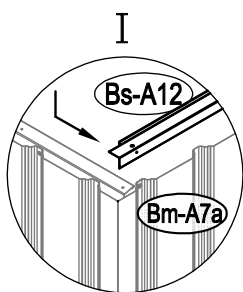

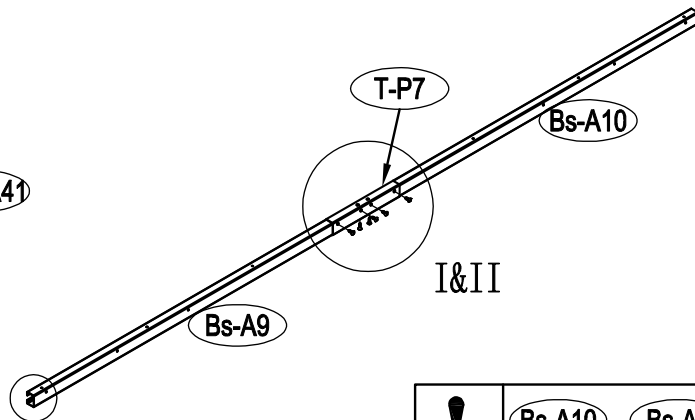
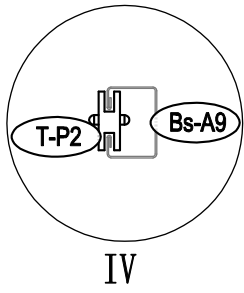
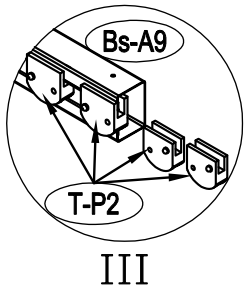
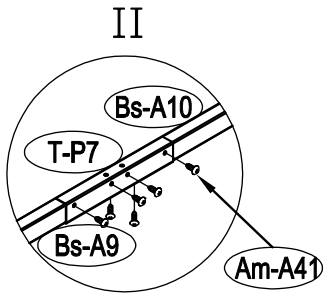
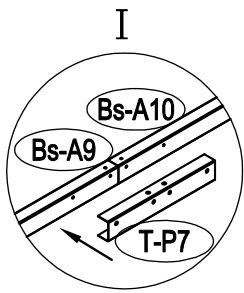

Am-A41  x3



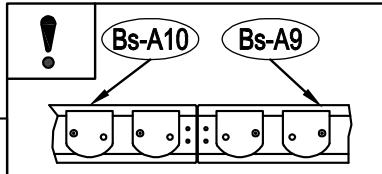

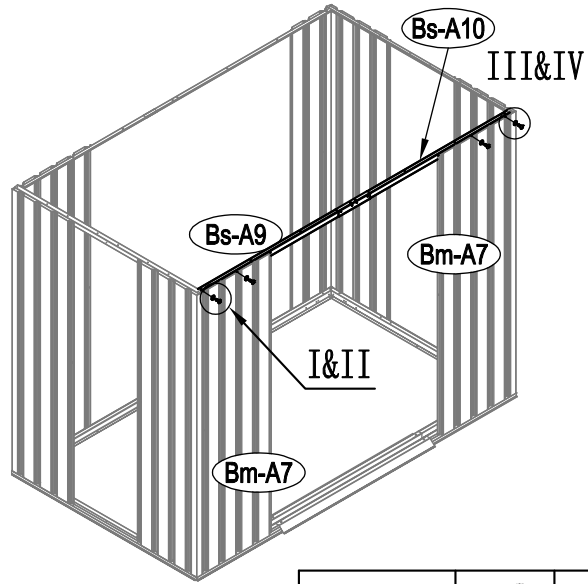
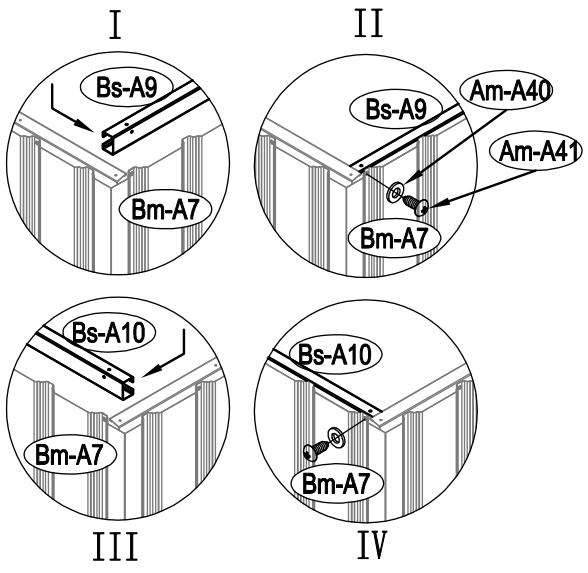
Am-A41  x6





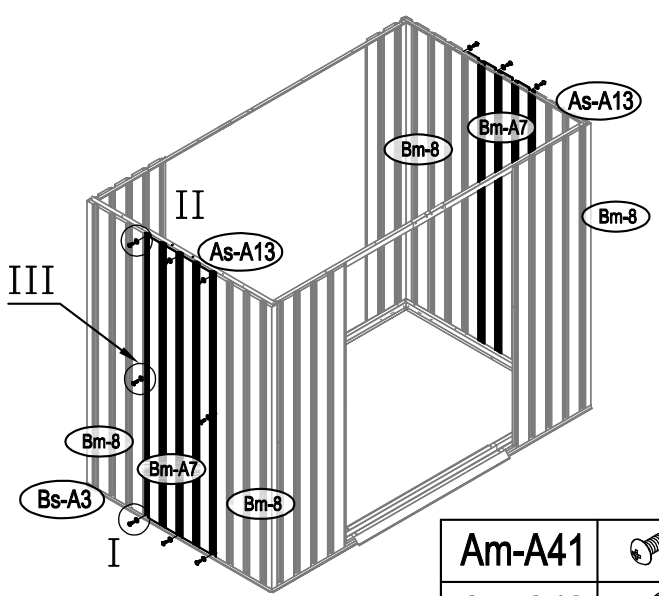
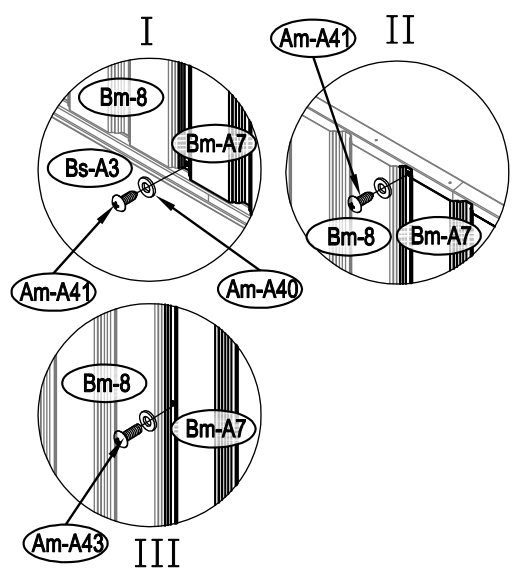

Am-A41		x4
--------	---	----

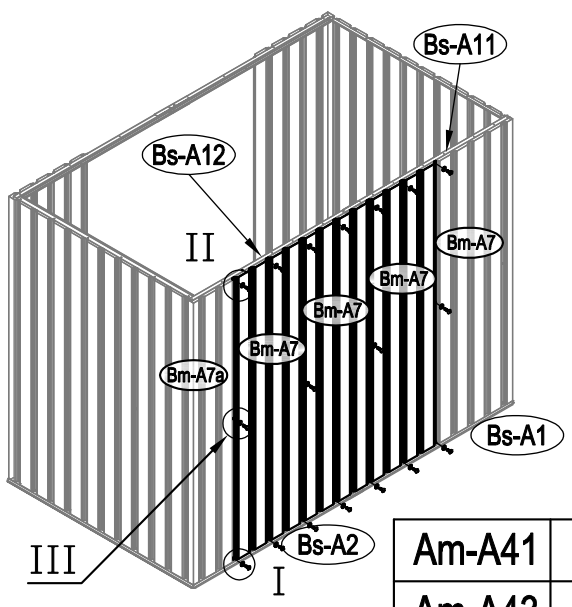
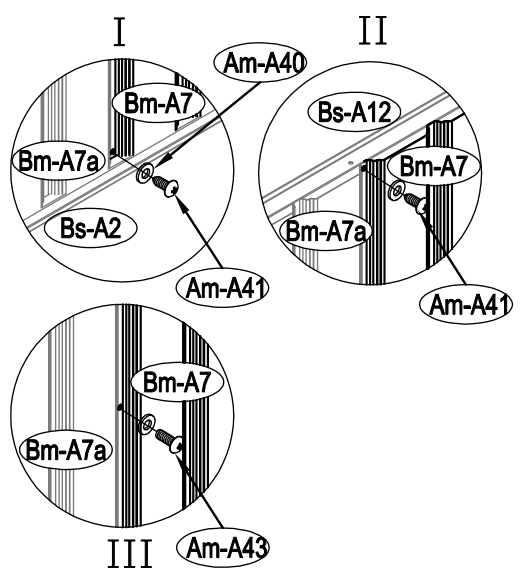

Am-A41		x12
Am-A43		x4



Am-A41		x14
Am-A43		x4

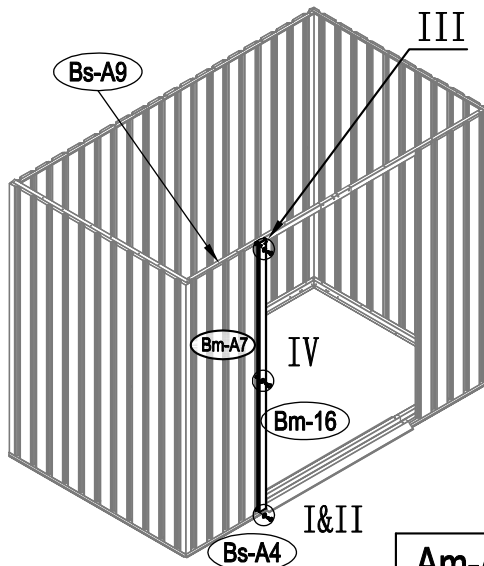
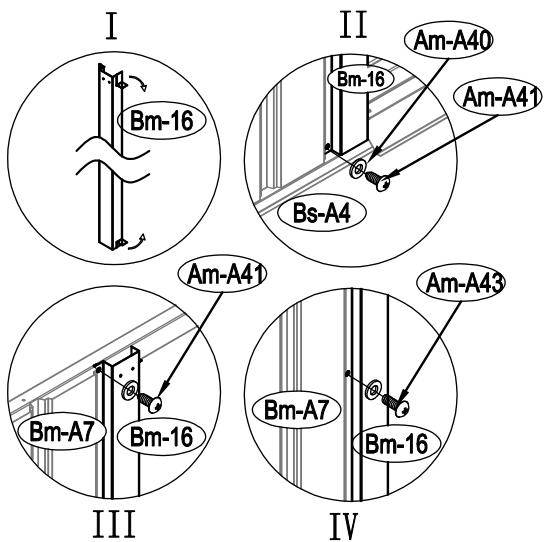

Am-A41		x2
Am-A43		x1

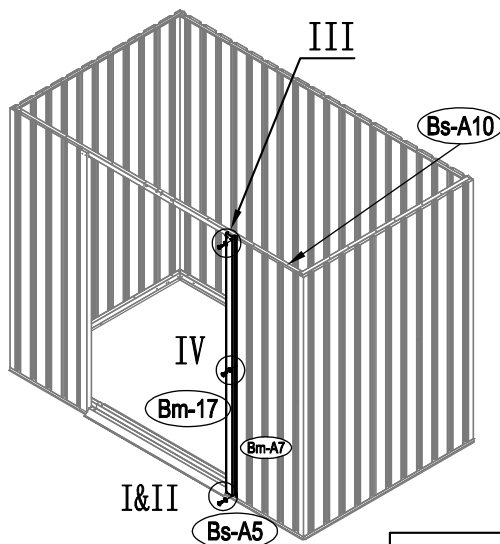
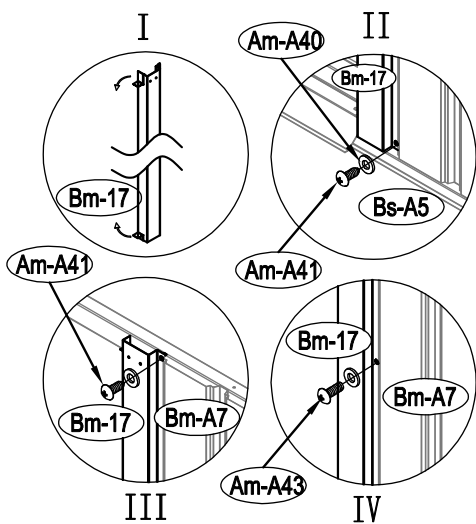

Am-A41		x2
Am-A43		x1

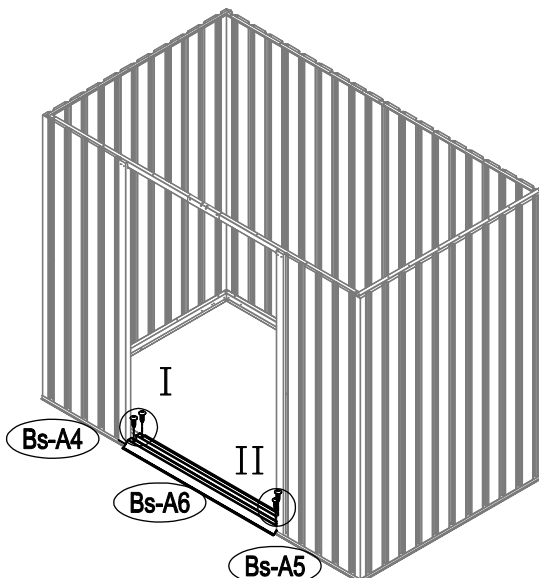
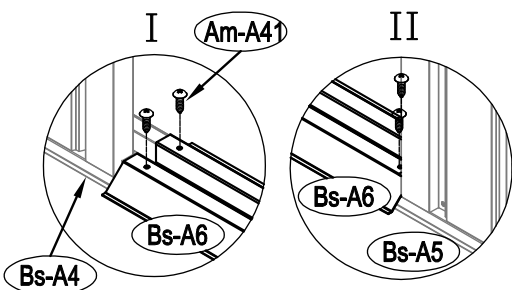

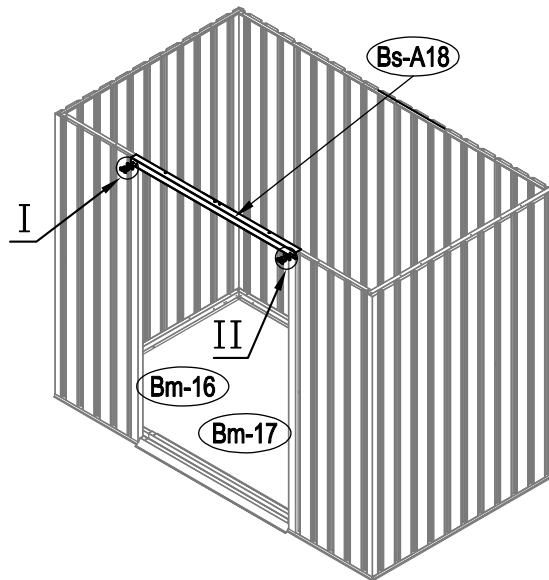
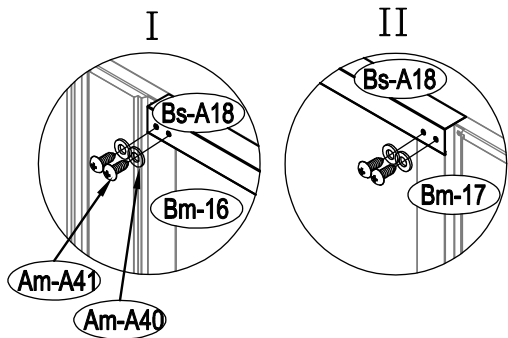

Am-A41		x4
--------	--	----

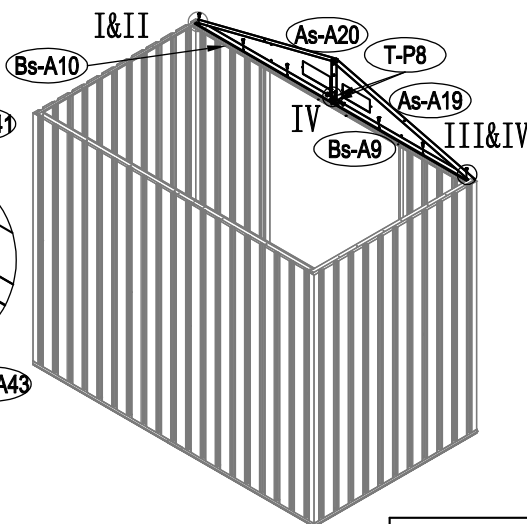
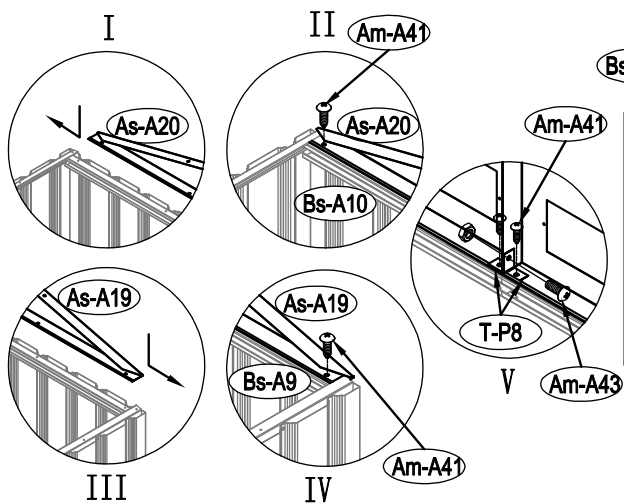

Am-A41		x4
--------	---	----



Am-A41		x8
Am-A43		x1

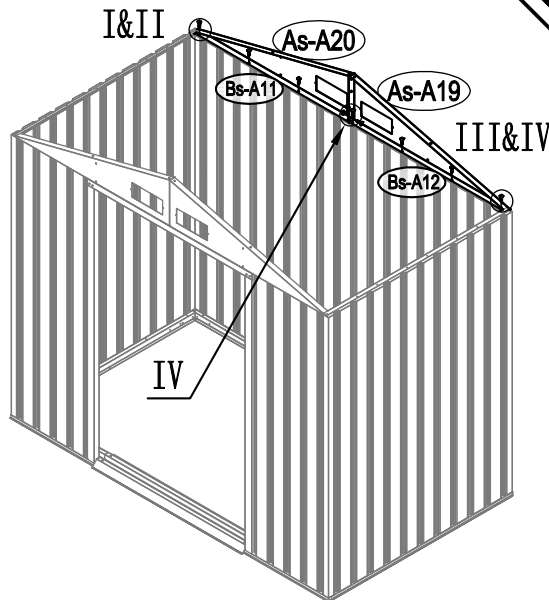
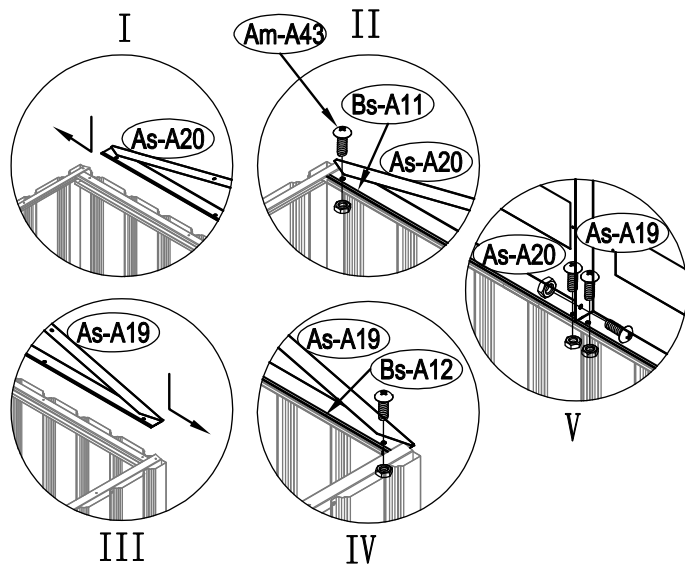

Am-A43		x9
--------	---	----

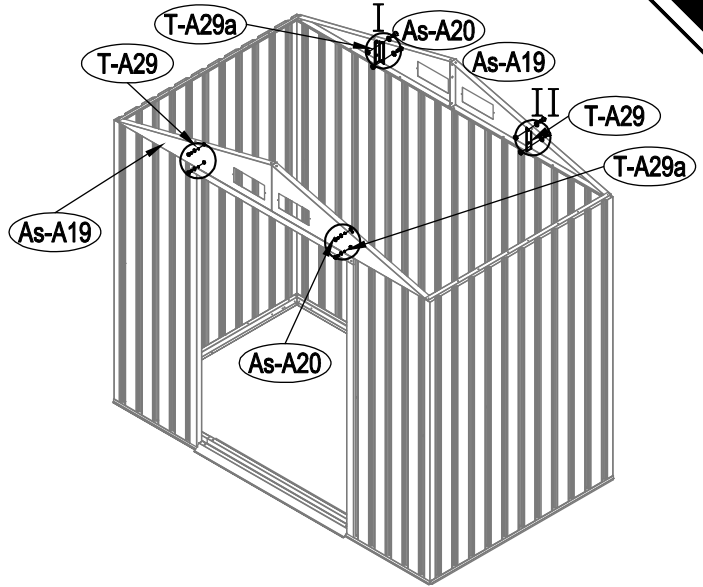
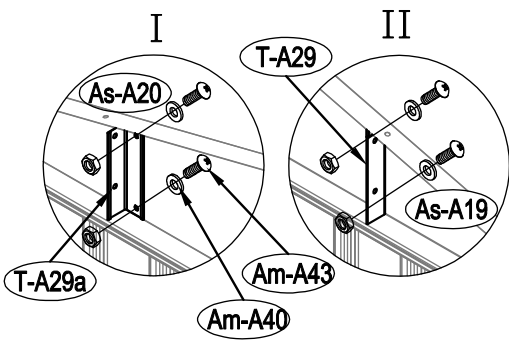

Am-A43  x8

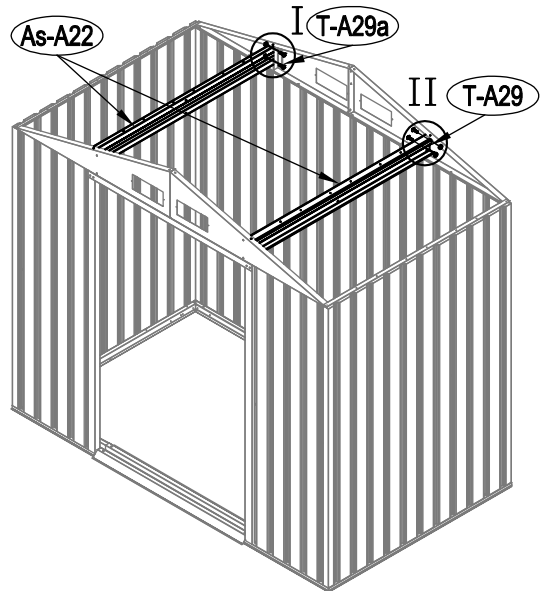
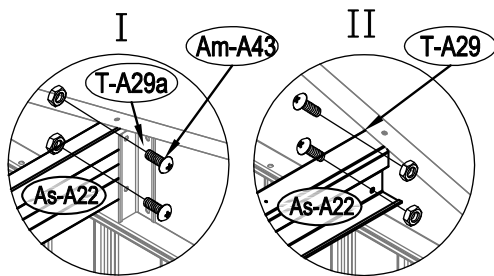

Am-A43  x8

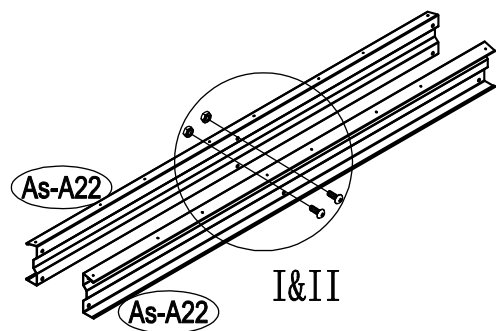
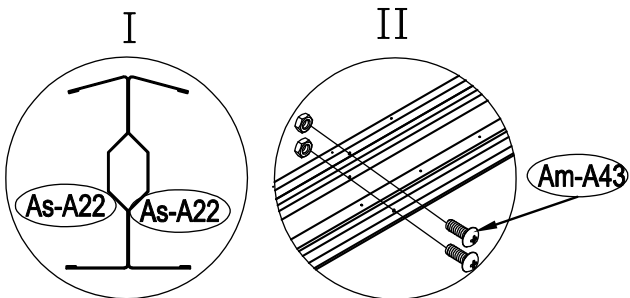

Am-A43  x2

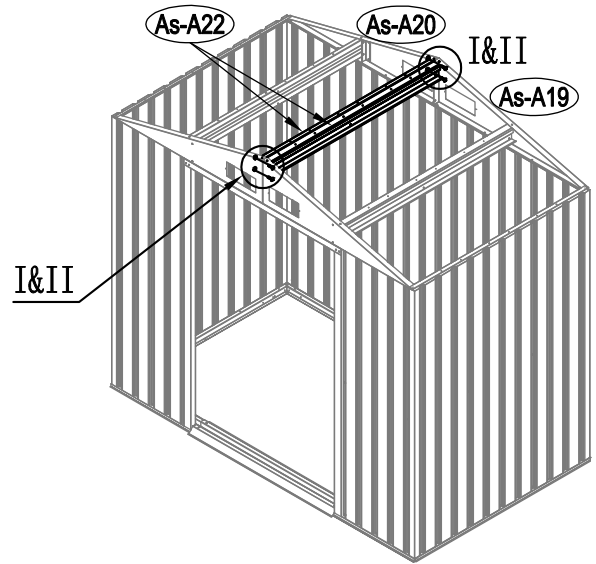
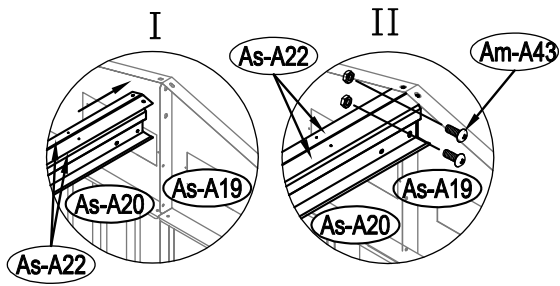

Am-A43  x4

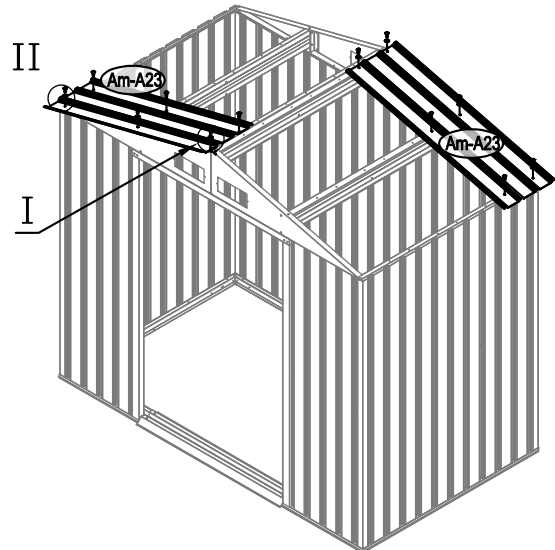
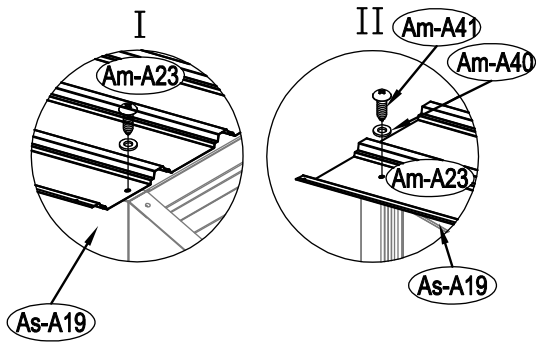

Am-A41  x12

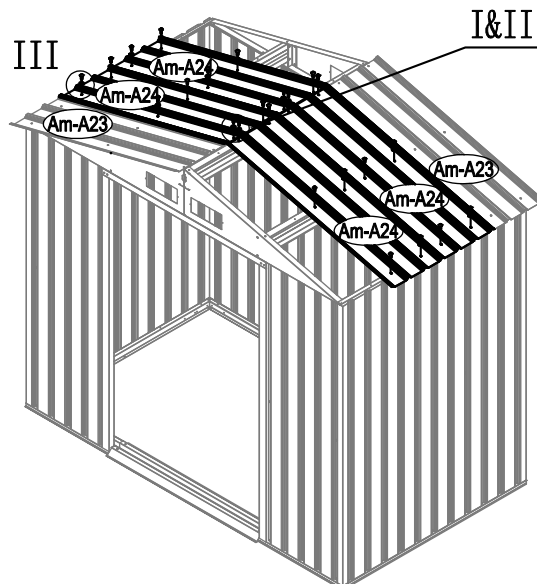
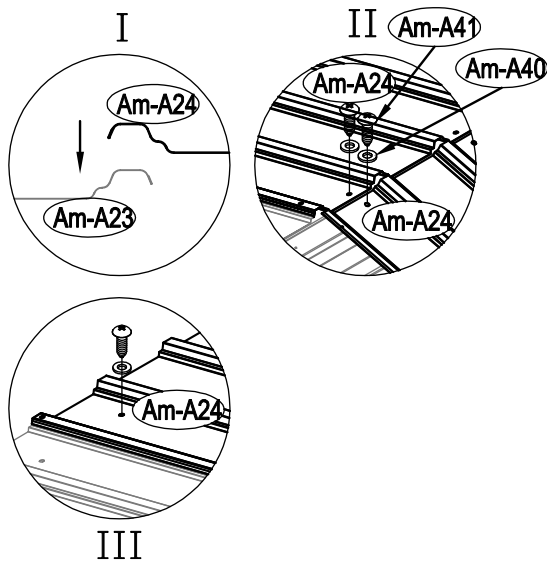

Am-A41  x24

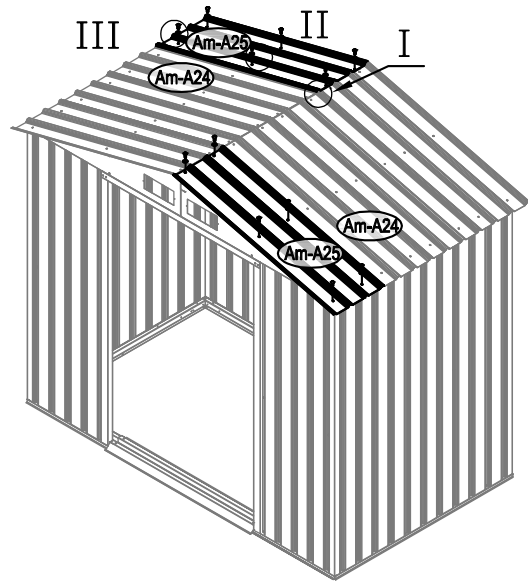
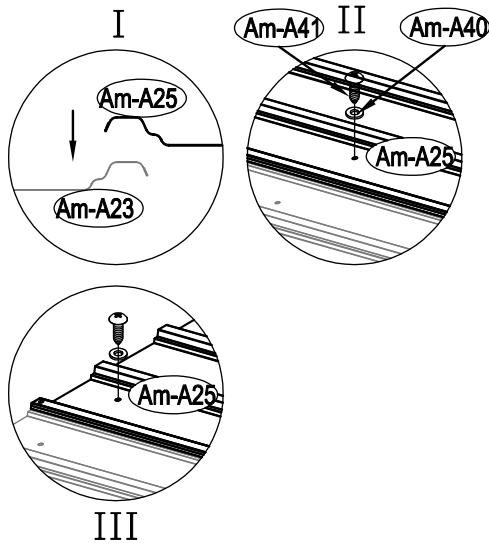

Am-A41  x12

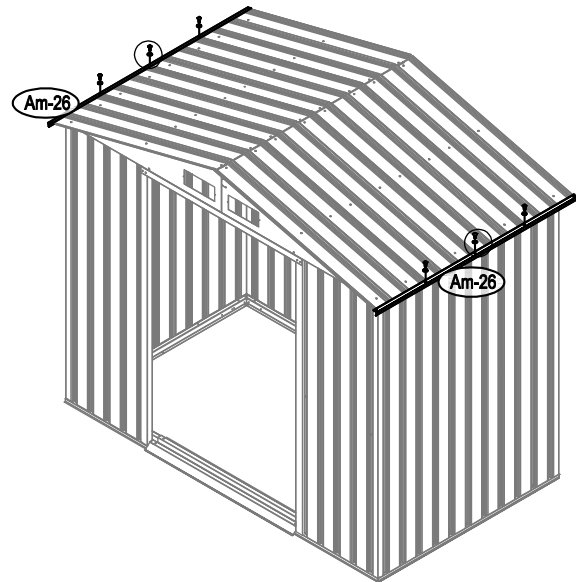
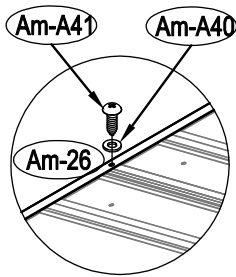

Am-A41  x6

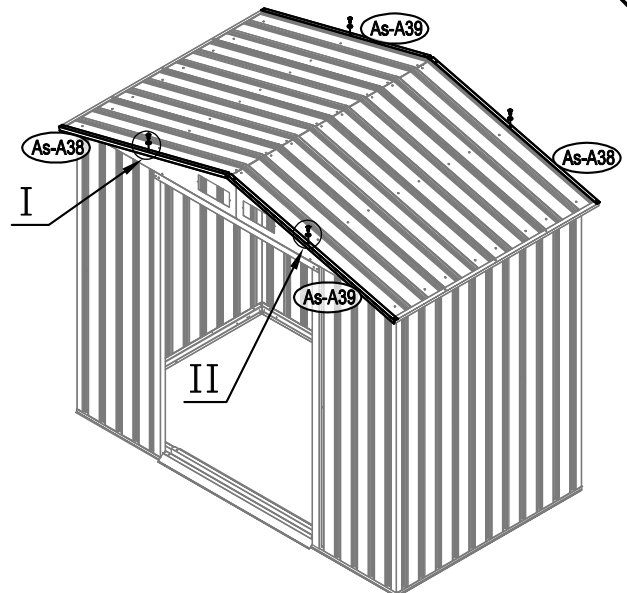
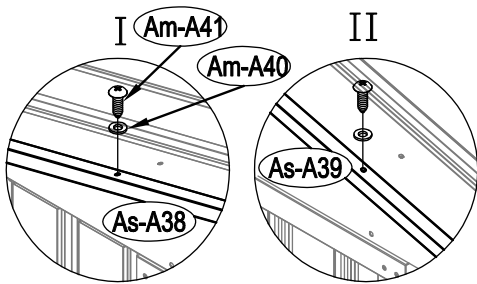

Am-A41  x4

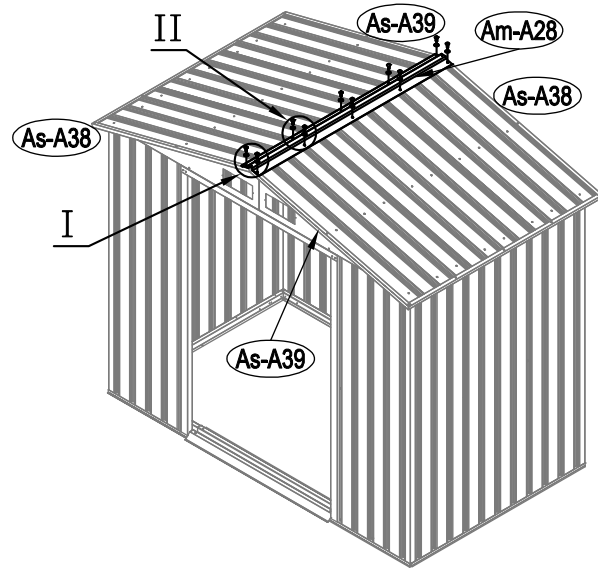
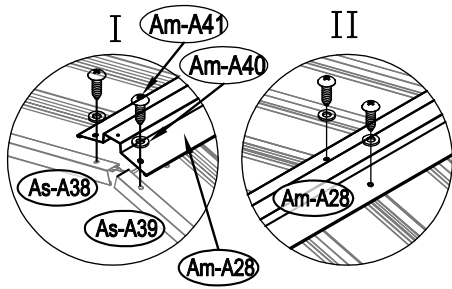

Am-A41  x10

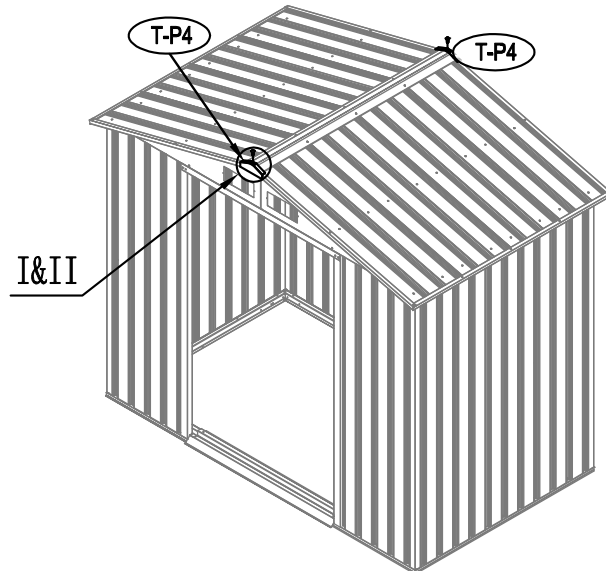
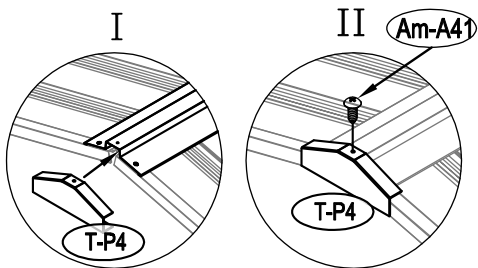

Am-A41  x2

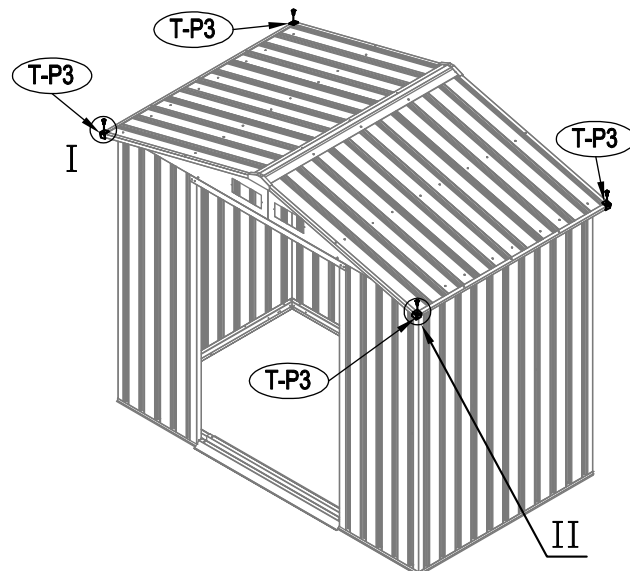
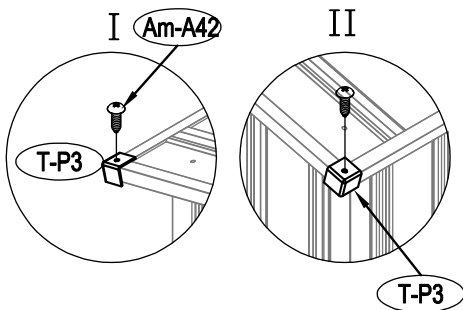

Am-A42  x4

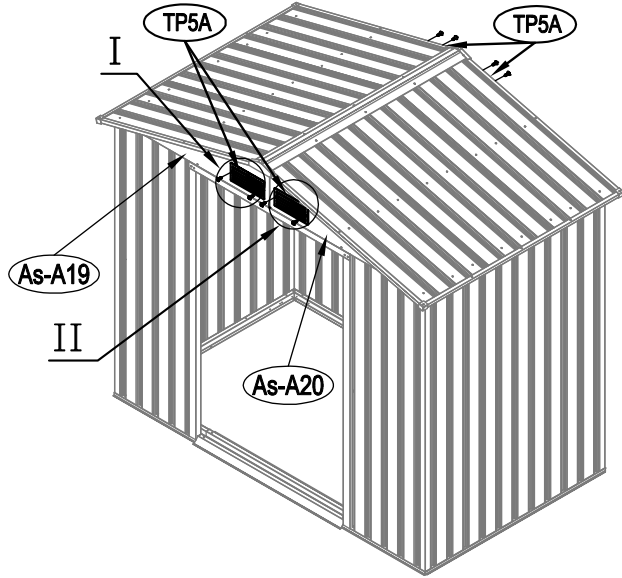
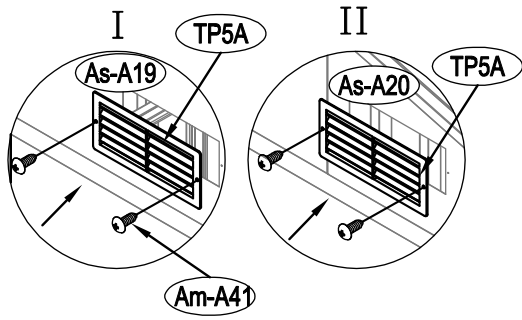

Am-A41  x8

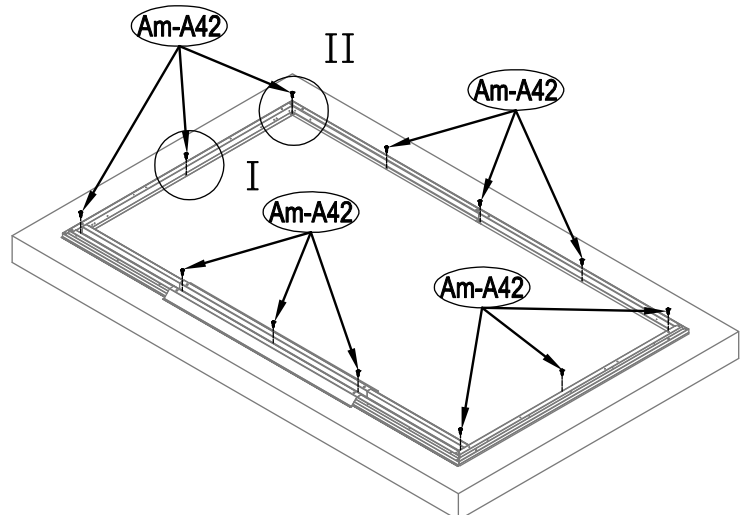
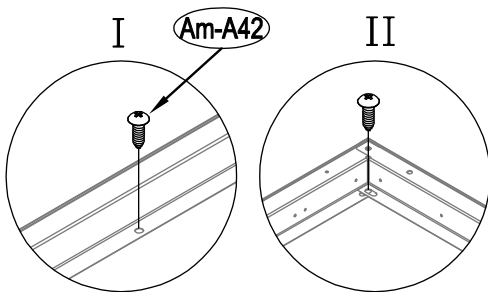
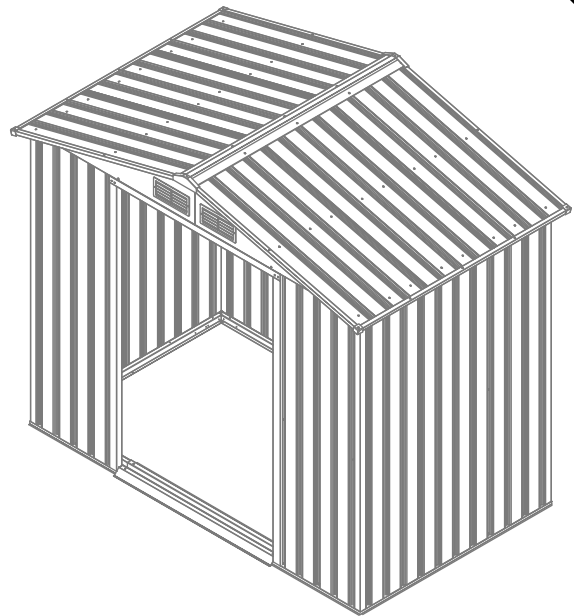
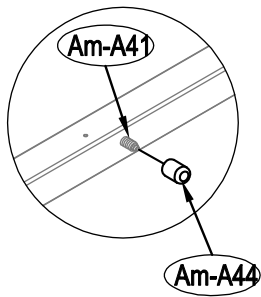

Am-A42  x12

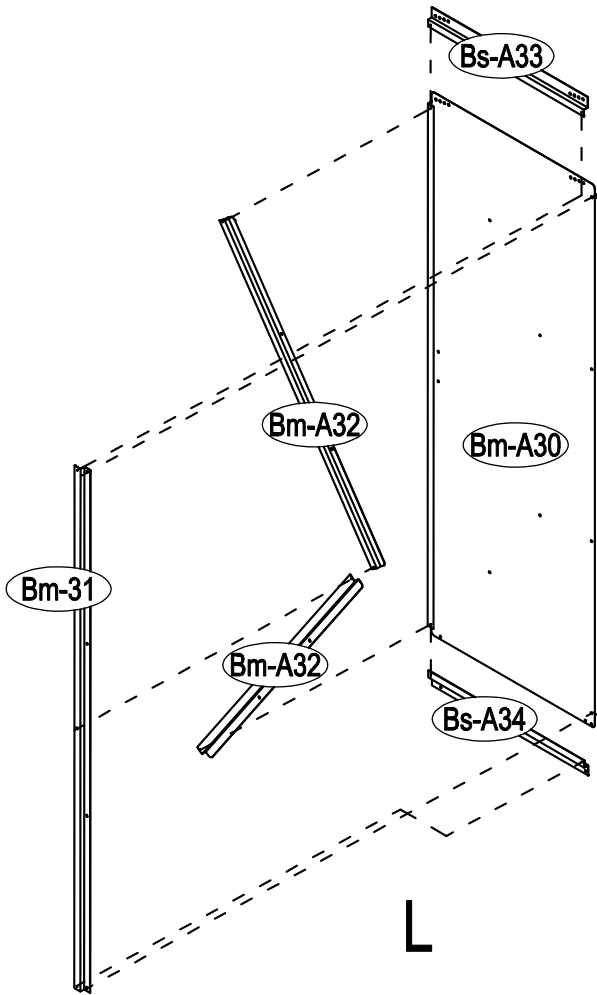

L

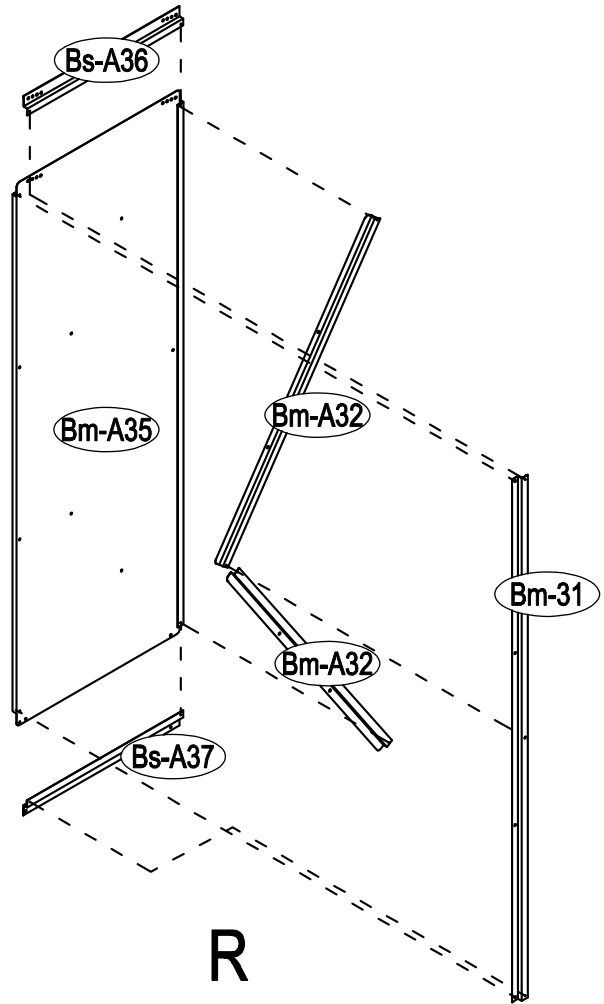

R

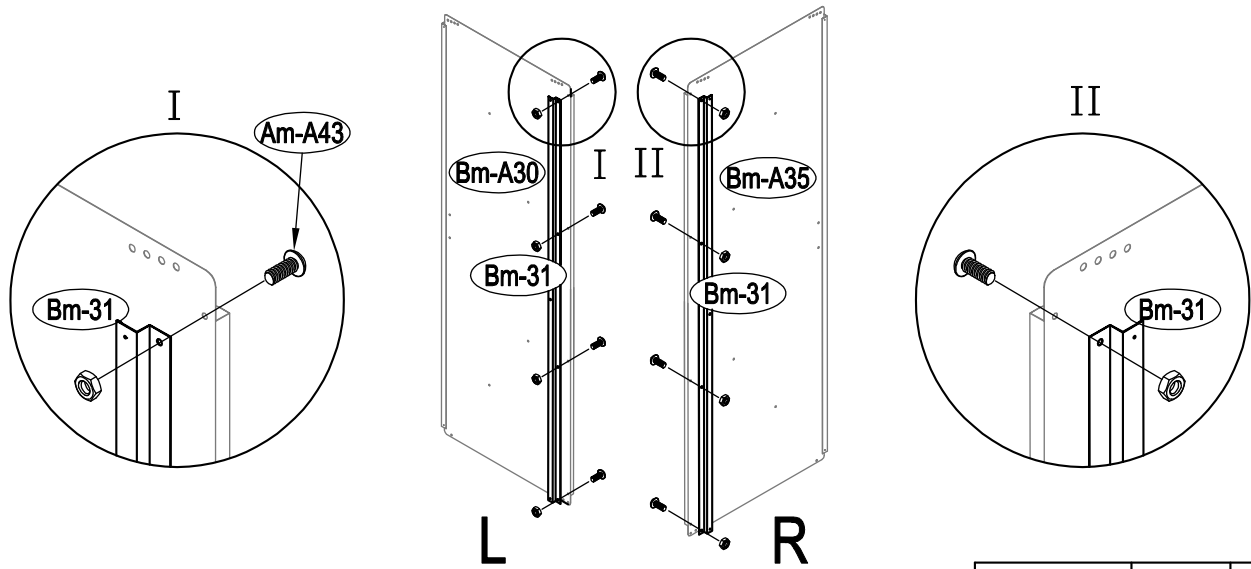

Am-A43		x8
--------	---	----

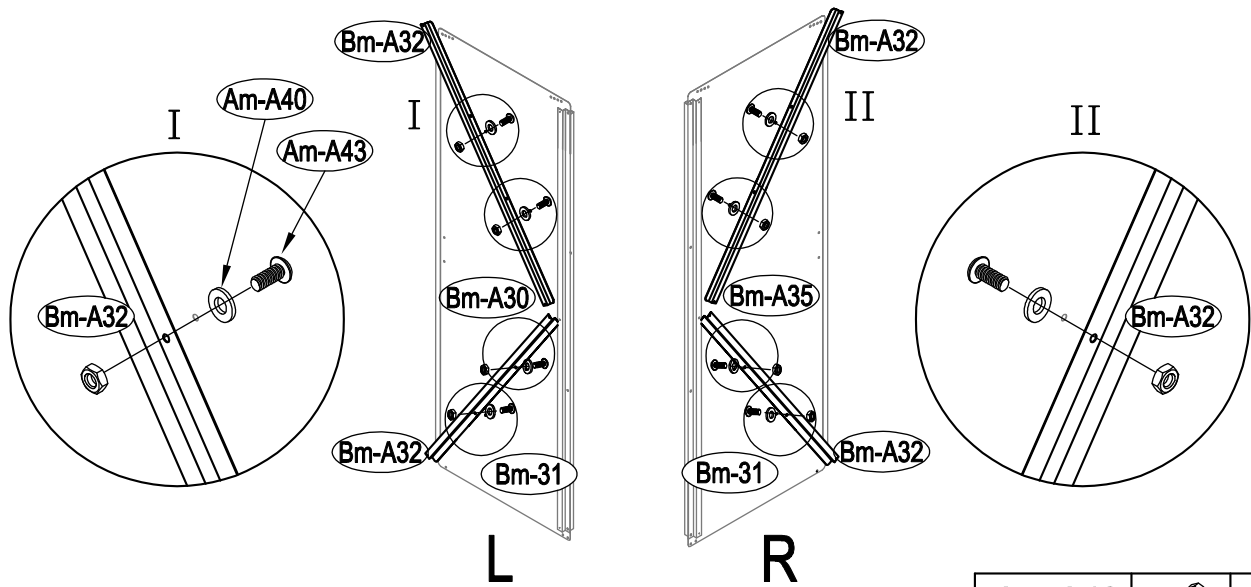

Am-A43		x8
--------	---	----

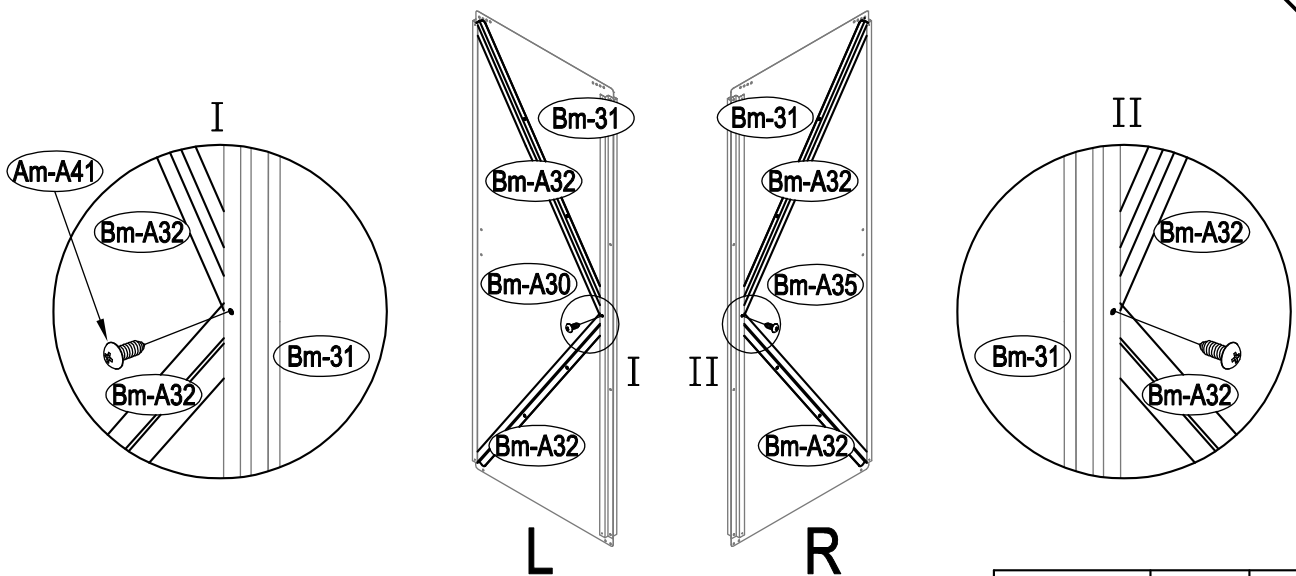

Am-A41		x2
--------	---	----

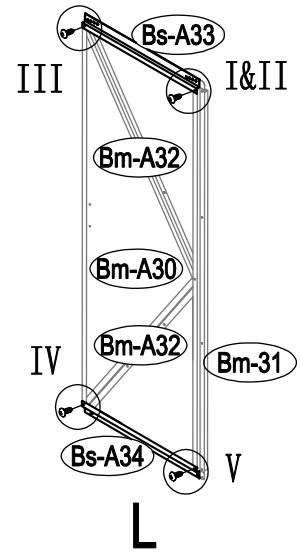
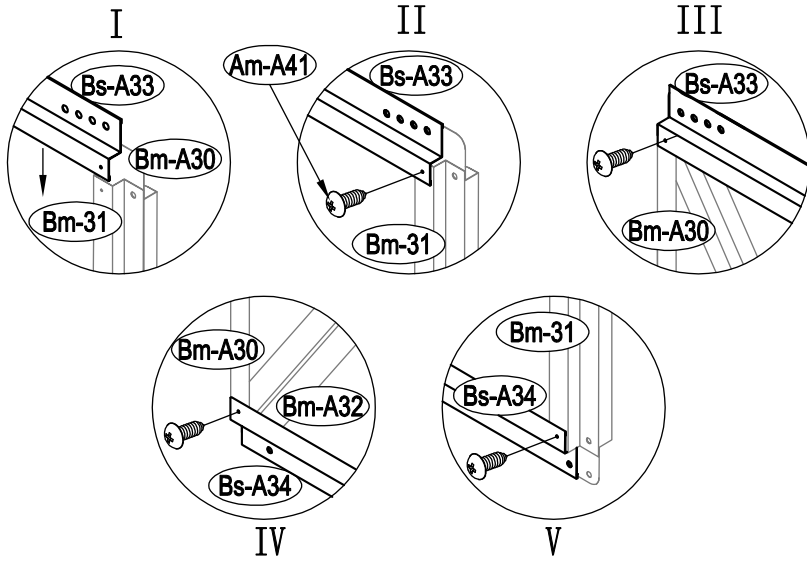

Am-A41		x4
--------	--	----

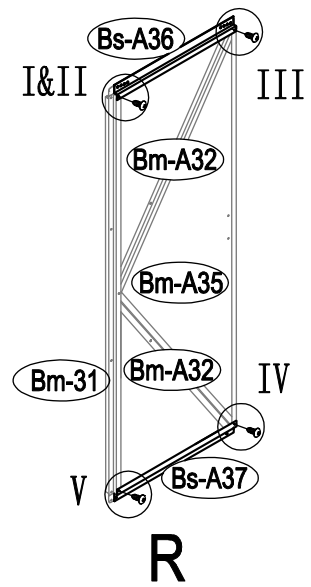
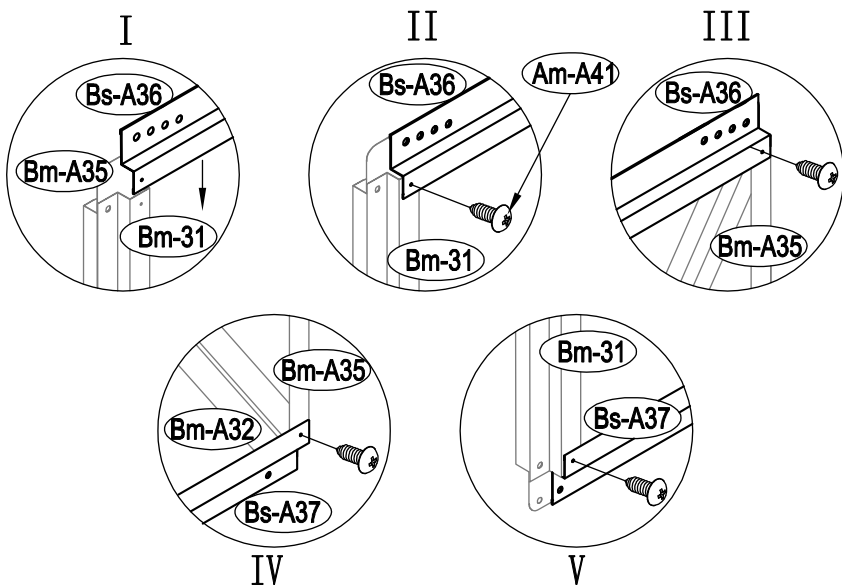

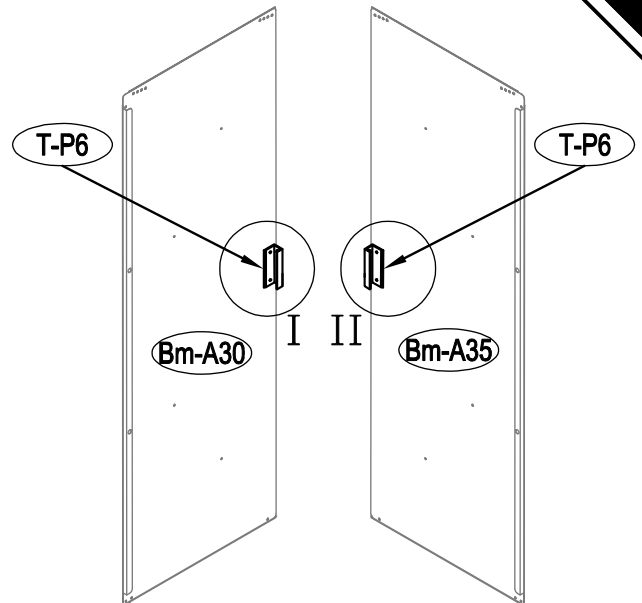
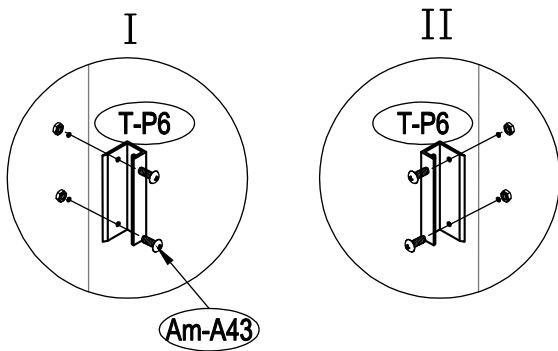

Am-A41		x4
--------	--	----



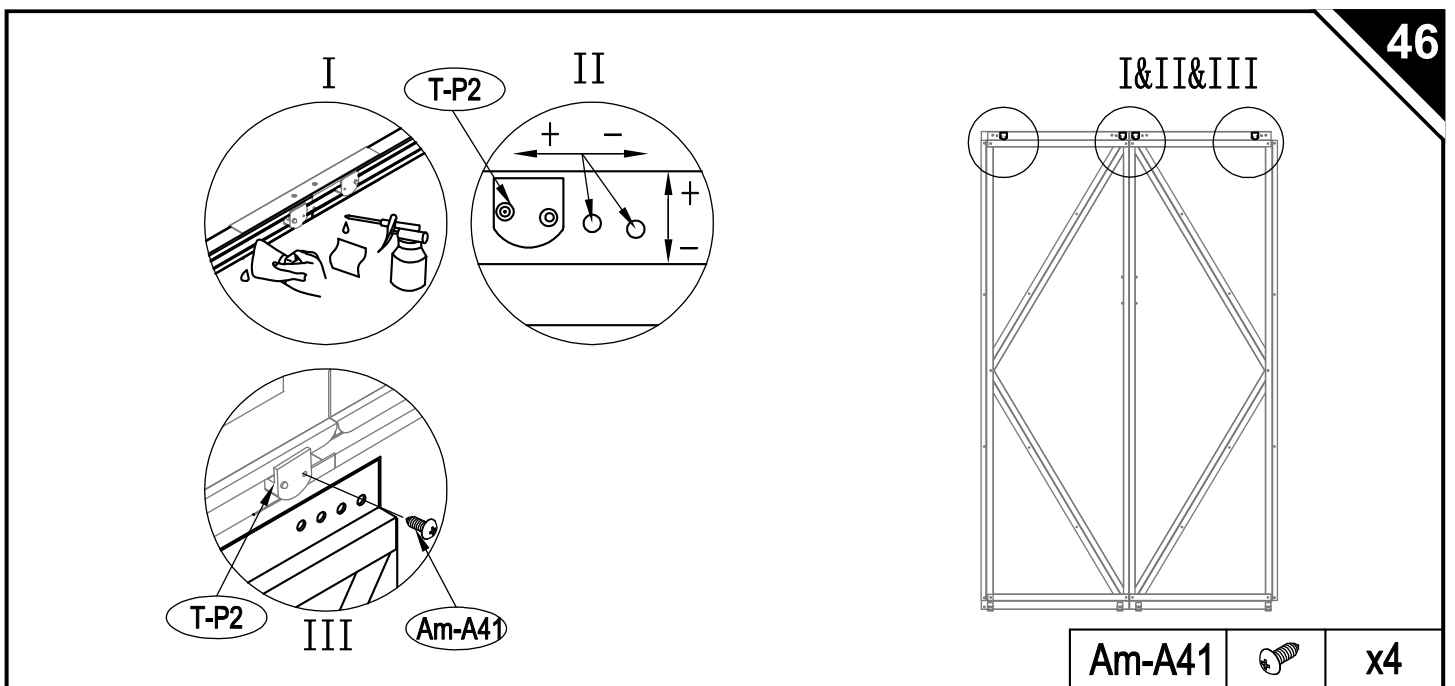
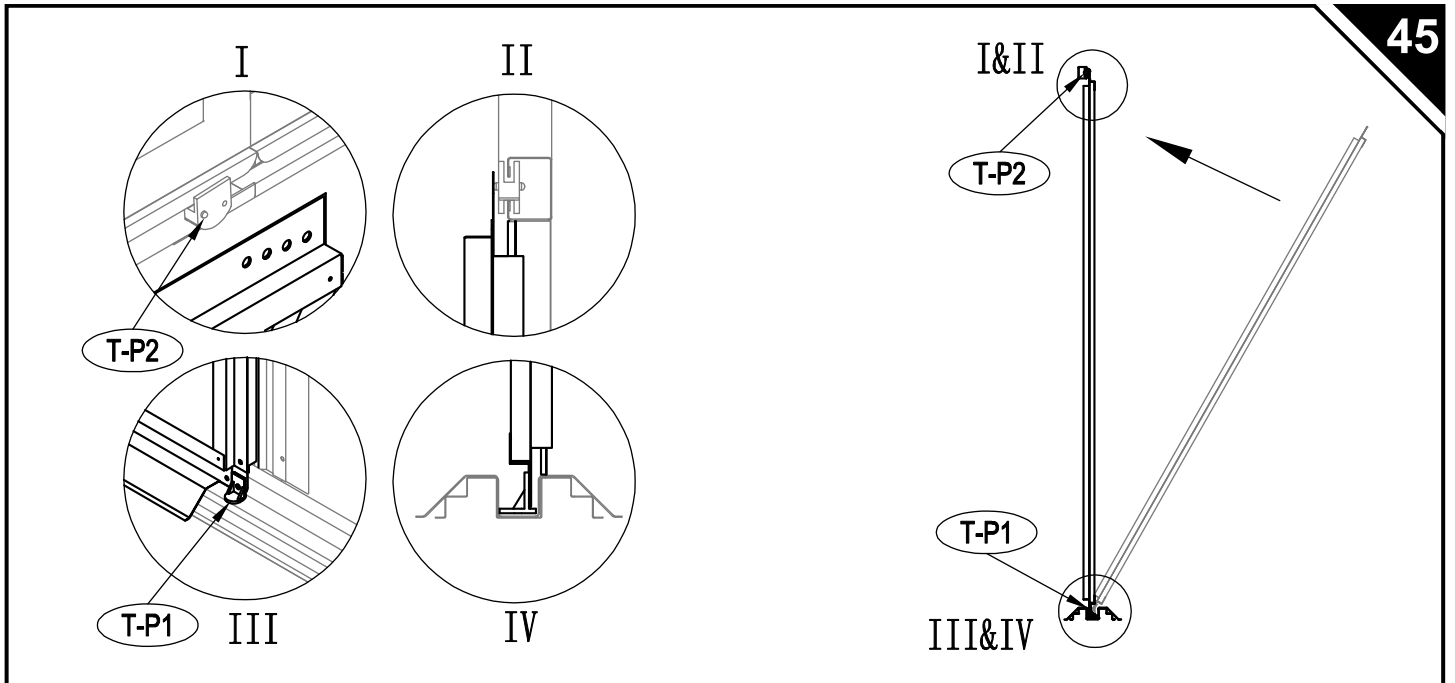
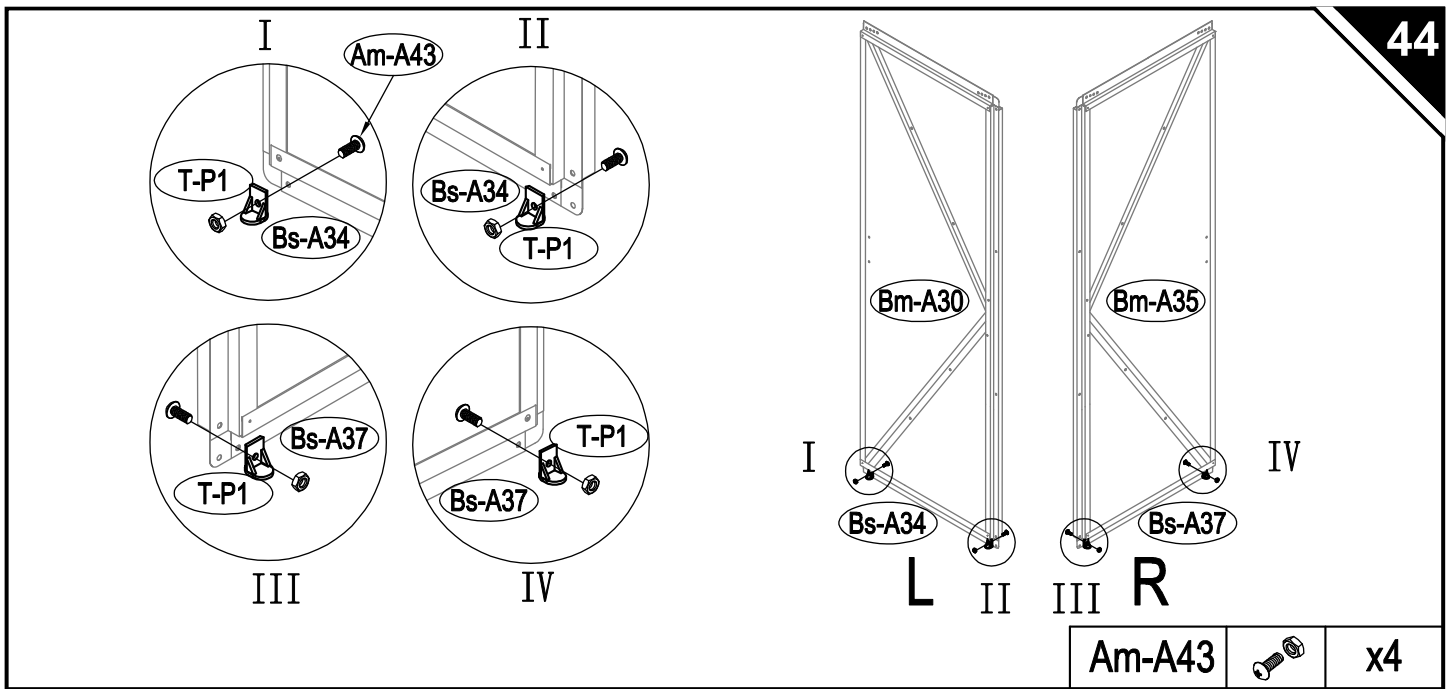

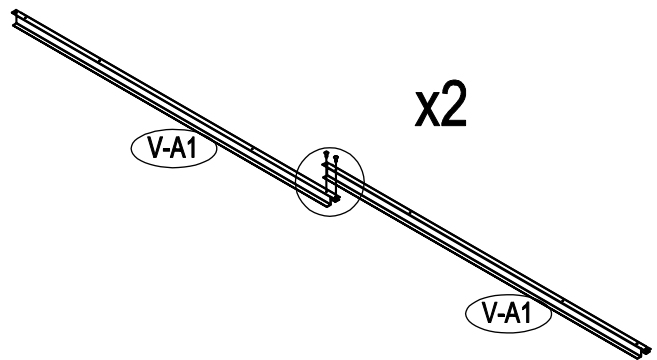
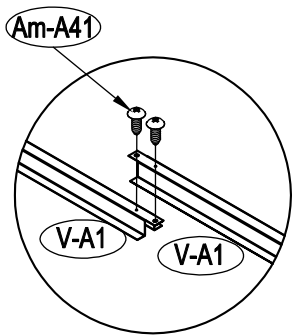
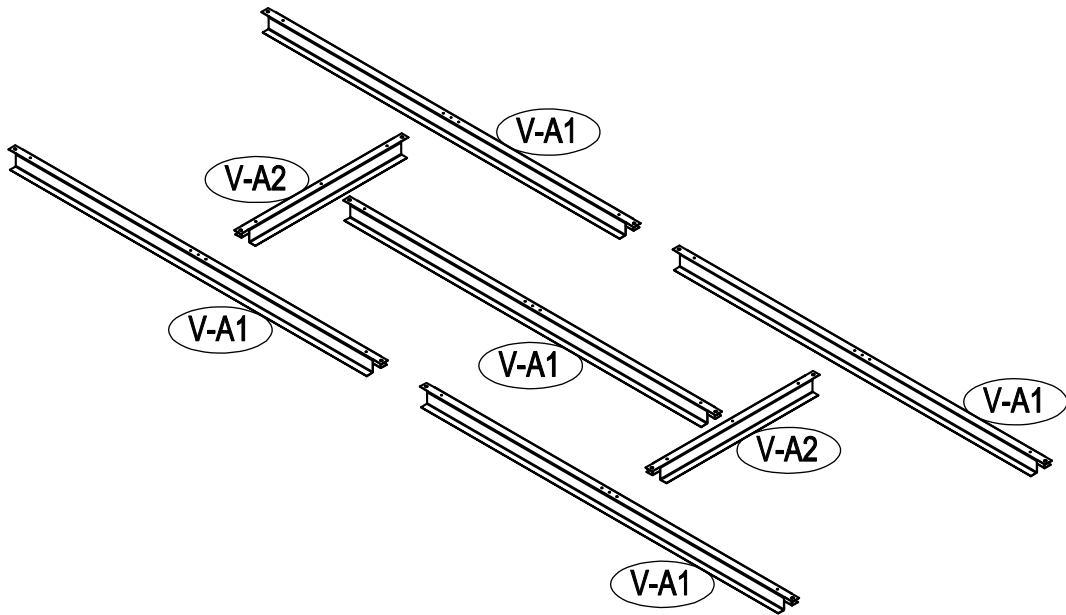
Am-A43		x4
--------	--	----



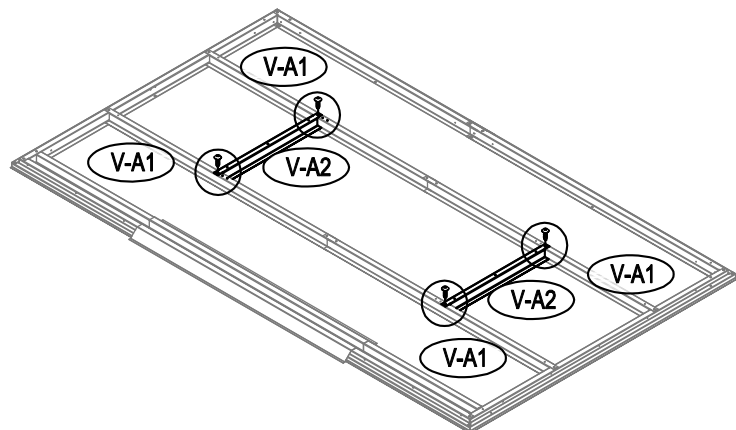
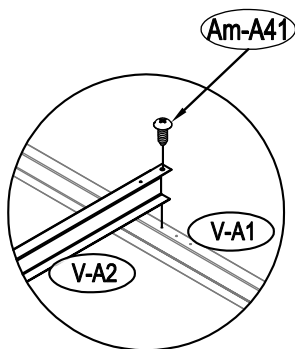

Am-A41		x4
--------	---	----



Am-A41		x4
--------	---	----

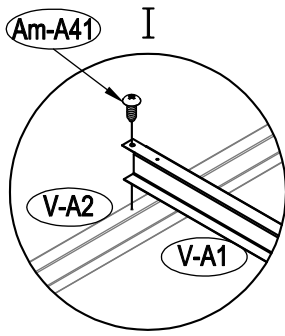

x2

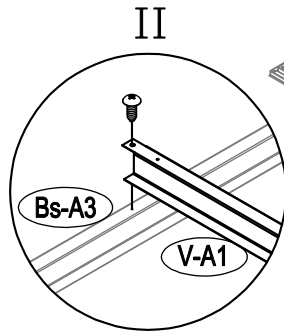

x4

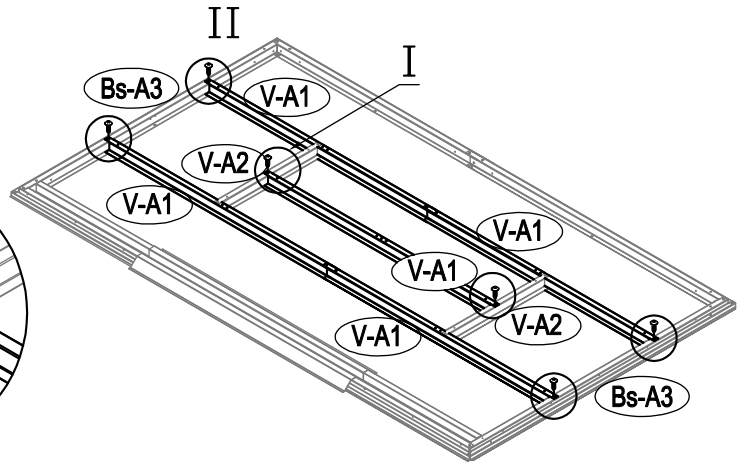

Am-A41		x6
--------	---	----

